

SANICA

Pipe Price List

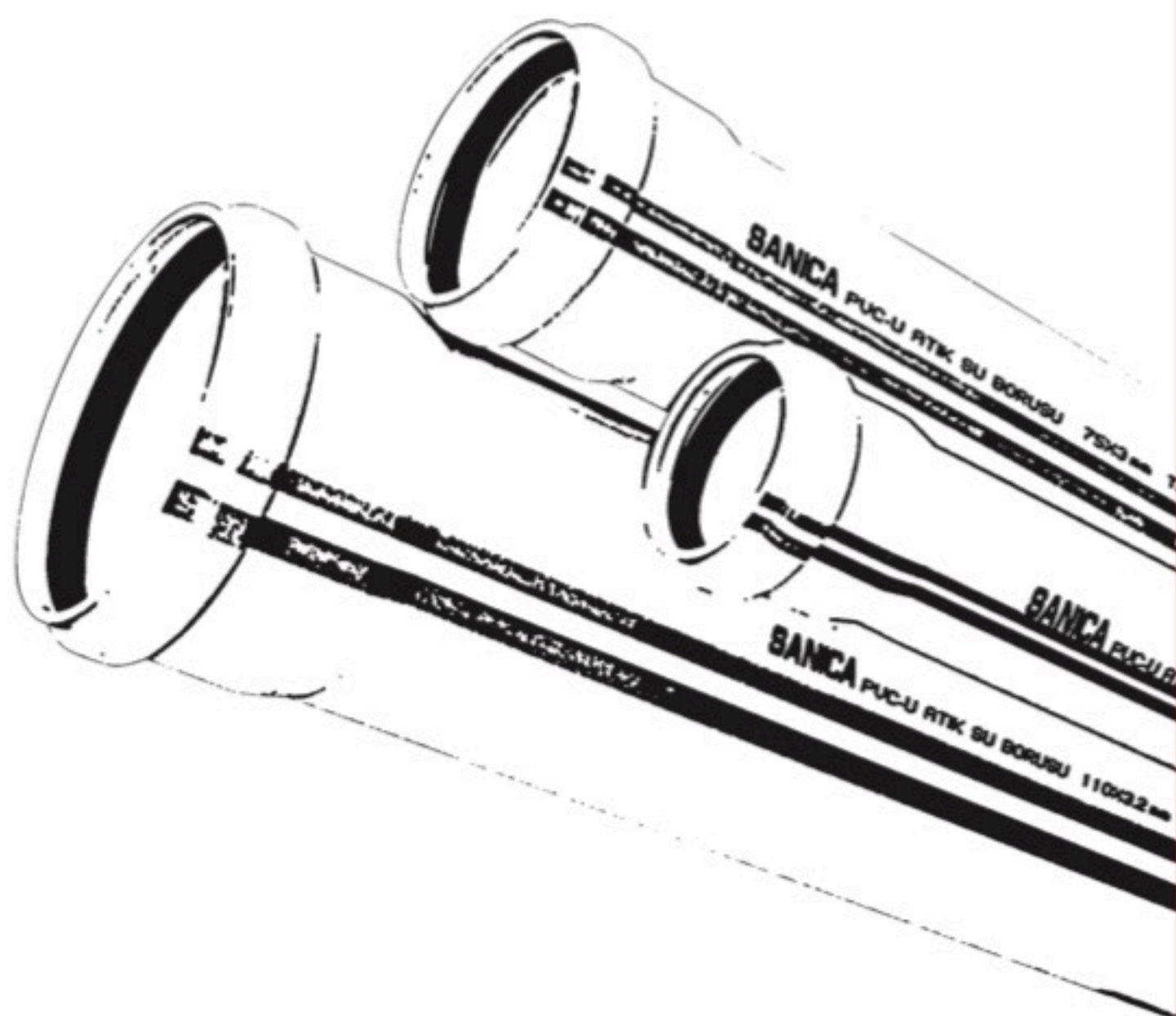



SANITARY PIPES
SIHHİ TESİSAT BORULARI

03

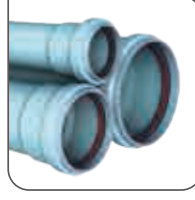

SILENZIO WASTE WATER PIPES and FITTINGS
SİLENZİO ATIK SU BORULARI ve EK PARÇALARI

37



SANITARY PIPE FITTINGS
SIHHİ TESİSAT BORUSU EK PARÇALARI

06



SUPER SILENT PIPE and FITTINGS
SÜPER SESSİZ BORU VE EK PARÇALARI

46



EXTRA GAS BOILER INSTALLATION SET
EXTRA KOMBİ BAĞLANTI SETİ

15

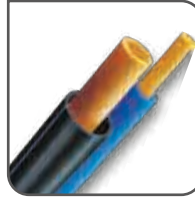

(PE) INFRASTRUCTURE SYSTEMS
(PE) ALTYAPI SİSTEMLERİ

50



INDOOR HEATING SYSTEMS
BİNA İÇİ ISITMA SİSTEMLERİ

17



CORRUGATED SEWER PIPE and FITTINGS
KORUGE KANALİZASYON BORUSU ve EK PARÇALARI

57



PEX, AL-PEX PIPES and FITTINGS
PEX, AL-PEX BORULARI ve EK PARÇALARI

21



PVC PRESSURE CLEAN WATER PIPES
PVC BASINÇLI TEMİZ SU BORULARI

63

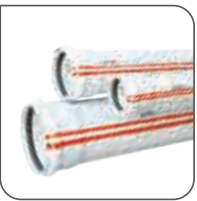

WASTE WATER PIPES and FITTINGS
ATIK SU BORULARI ve EK PARÇALARI

25

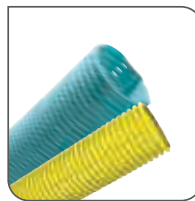

DRAINAGE PIPES
DRENAJ BORULARI

66

PPR-C PIPES WELDING INSTRUCTIONS

PPR-C BORU KAYNAK TALİMATI



1 Set welding machine to 260°C by thermotic control system. Be sur e welding machine warmed up to 260°C and heating light is off.

Kaynak makinesi üzerindeki termostat vasıtası ile 260°C'ye ayarlanır. Makinenin 260°C'de olduğundan ısıtıcı lambasının sönmesi ile emin olunur.



2 Be sur e welding tools, pipe and fitting are clean.

Kaynak paftalarının ve kaynak edilecek ek parça ve boruların kaynak yüzeylerinin temiz olup olmadığı kontrol edilir.



3 Cut the pipe perpendicular to it's axis with pipe scissor.

Boru özel makası vasıtası ile eksenine dik olacak şekilde kesilir.



4 Push the pipe and the fittings synchronically and perpendicular to the welding tool and wait until the DVS guideline.

Boru ve ek parçası aynı düzlemde olması şartıyla kaynak paftasına doğru itilir ve tabloda gösterilen süre kadar beklenip boru ve ek parçasının doğru sıcaklığa ulaşması sağlanır.



5 Pull the pipe and the fitting out of the welding tool and push them towards each other until the stopper which is located in the fitting.

Kaynak edilecek boru ve ek parçası hiç beklemeden aynı ekseninde, kesinlikle bir açı oluşmayacak şekilde ek parça içerisinde bulunan stoplayıcıya gelene kadar itilir. Bu işlem sırasında boru veya ek parçası kesinlikle döndürülmemelidir soğuma periyodunda da kesinlikle hareket ettirilmemelidir.

Not. 1- Sanica pipe product guarantee is valid only if the installation is performed according to above mentioned guidelines.

Sanica boru sadece yukarıdaki şartlara uyularak yapıldığında sızdırmazlığı garanti eder.

2- Sanica pipe guarantee an oxygen extra protect combi pipe system only if it is installed using original Sanica fittings.

Oxygen ekstra kombi borusu sadece Sanica ek parçaları ile birlikte kullanılmalıdır, aksi takdirde sızdırmazlık ve boru ömrü garanti edilemez.

WELDING PARAMETERS KAYNAK PARAMETRELER

OUTER DIAMETER (mm) DIŞ ÇAP (mm)	HEATING TIME (sn) ISITMA ZAMANI (sn)	WELDING TIME (sec.) KAYNAMA SÜRESİ (sn)	COOLING PERIOD (min.) SOĞUTMA ZAMANI (dakika)	DVS 2207 DVS 2207
16	5	4	2	Manual welding machine Manuel Kaynak Makinası
20	5			
25	7			
32	8	6	4	
40	12			
50	18	8	6	Welding Machine Kaynak Makinası
63	24			
75	30	10	8	
90				

SANICA

Pipe Boru

SANITARY PIPES
SIHHİ TESİSAT BORULARI



PPR-C PIPES
PPR-C BORULAR



PPR-C PIPE PN 16
PPR-C BORU PN 16

	Code Kod			Diameter Çap (mm)	Bundle Quantity Paket Miktarı (m)	Bundle Dimension Paket Ebatı (cm)	Bundle Weight Paket Ağırlığı (kg)	Price Fiyat (USD)
	White Beyaz	Green Yeşil	Grey Gri					
502-600200	700200	800200	40x3.7	40	11x21x400	21.86	3,11	
502-600202	700202	800202	50x4.6	20	15.5x10.5x400	17.20	4,77	
502-600204	700204	800204	63x5.8	16	25x7x400	21.56	7,57	
502-600206	700206	800206	75x6.8	12	8x22x400	23.03	10,74	
502-600208	700208	800208	90x8.2	8	9.5x18x400	22.03	16,42	
502-600210	700210	800210	110x10	4	11.5x11.5x400	16.59	26,51	
502-600212	700212	800212	125x11.4	4	12.5x12.5x400	21.27	32,94	

Note: Available with black U.V. Additive upon request.

Not: İstenirse siyah U.V. katkılı olarak üretilebilir.



PPR-C PIPE PN 20
PPR-C BORU PN 20

	Code Kod			Diameter Çap (mm)	Bundle Quantity Paket Miktarı (m)	Bundle Dimension Paket Ebatı (cm)	Bundle Weight Paket Ağırlığı (kg)	Price Fiyat (USD)
	White Beyaz	Green Yeşil	Grey Gri					
502-600250	700250	800250	20x2.8	100	7x18.5x400	14.00	0,82	
502-600252	700252	800252	25x3.5	80	8x18x400	17.42	1,32	
502-600254	700254	800254	32x4.4	60	10x19x400	21.00	2,22	
502-600256	700256	800256	40x5.5	40	11x21x400	21.86	3,48	
502-600258	700258	800258	50x6.9	20	15.5x10.5x400	17.20	5,46	
502-600260	700260	800260	63x8.6	16	25x7x400	21.56	8,72	
502-600262	700262	800262	75x10.3	12	8x22x400	23.03	12,42	
502-600264	700264	800264	90x12.3	8	9.5x18x400	22.03	17,85	
502-600266	700266	800266	110x15.1	4	11.5x11.5x400	16.59	28,56	
502-600268	700268	800268	125x17.1	4	12.5x12.5x400	21.27	36,72	

Note: Available with black U.V. Additive upon request.

Not: İstenirse siyah U.V. katkılı olarak üretilebilir.



PPR-C PIPE PN 25
PPR-C BORU PN 25

	Code Kod			Diameter Çap (mm)	Bundle Quantity Paket Miktarı (m)	Bundle Dimension Paket Ebatı (cm)	Bundle Weight Paket Ağırlığı (kg)	Price Fiyat (USD)
	White Beyaz	Green Yeşil	Grey Gri					
502-600300	700300	800300	20x3.4	100	7x18.5x400	16.30	0,92	
502-600302	700302	800302	25x4.2	80	8x18x400	20.14	1,44	
502-600304	700304	800304	32x5.4	60	10x19x400	24.78	2,62	
502-600306	700306	800306	40x6.7	40	11x21x400	25.66	4,02	
502-600308	700308	800308	50x8.3	20	15.5x10.5x400	20.28	6,33	
502-600310	700310	800310	63x10.5	16	25x7x400	25.36	10,12	
502-600312	700312	800312	75x12.5	12	8x22x400	26.94	14,44	
502-600314	700314	800314	90x15	8	9.5x18x400	25.88	20,83	
502-600316	700316	800316	110x18.3	4	11.5x11.5x400	19.38	33,22	
502-600318	700318	800318	125x20.8	4	12.5x12.5x400	24.94	44,88	

Note: Available with black U.V. Additive upon request.

Not: İstenirse siyah U.V. katkılı olarak üretilebilir.

GLASS FIBER REINFORCED PIPES
CAM ELYAF TAKVİYELİ BORULAR

GLASS FIBER REINFORCED PIPE PN 20 (Composite Pipes)
CAM ELYAFLI PPR-C BORULAR PN 20 (Kompozit Borular)

Code Kod			Diameter Çap (mm)	Bundle Quantity Paket Miktarı (m)	Bundle Dimension Paket Ebatı (cm)	Bundle Weight Paket Ağırlığı (kg)	Price Fiyat (USD)
White Beyaz	Green Yeşil	Grey Gri					
502-600400	700400	800400	20x2.8	100	7x18.5x400	16.00	1,08
502-600402	700402	800402	25x3.5	80	8x18x400	19.98	1,58
502-600404	700404	800404	32x4.4	60	10x19x400	24.12	2,68
502-600406	700406	800406	40x5.5	40	11x21x400	25.10	4,18
502-600408	700408	800408	50x6.9	20	15.5x10.5x400	19.72	6,48
502-600410	700410	800410	63x8.6	16	25x7x400	24.75	10,42
502-600412	700412	800412	75x10.3	12	8x22x400	26.41	15,27
502-600414	700414	800414	90x12.3	8	9.5x18x400	25.27	23,12
502-600416	700416	800416	110x15.1	4	11.5x11.5x400	19.02	40,75
502-600418	700418	800418	125x17.1	4	12.5x12.5x400	24.40	58,16



GLASS FIBER REINFORCED PIPE PN 25 (Composite Pipes)
CAM ELYAFLI PPR-C BORULAR PN 25 (Kompozit Borular)

Code Kod			Diameter Çap (mm)	Bundle Quantity Paket Miktarı (m)	Bundle Dimension Paket Ebatı (cm)	Bundle Weight Paket Ağırlığı (kg)	Price Fiyat (USD)
White Beyaz	Green Yeşil	Grey Gri					
502-600350	700350	800350	20x3.4	100	7x18.5x400	18.30	1,18
502-600352	700352	800352	25x4.2	80	8x18x400	22.38	1,74
502-600354	700354	800354	32x5.4	60	10x19x400	27.48	3,12
502-600356	700356	800356	40x6.7	40	11x21x400	29.46	4,88
502-600358	700358	800358	50x8.3	20	15.5x10.5x400	22.90	7,64
502-600360	700360	800360	63x10.5	16	25x7x400	29.10	12,45
502-600362	700362	800362	75x12.5	12	8x22x400	30.91	18,88
502-600364	700364	800364	90x15.0	8	9.5x18x400	29.69	29,82
502-600366	700366	800366	110x18.3	4	11.5x11.5x400	22.32	49,12
502-600368	700368	800368	125x20.8	4	12.5x12.5x400	28.72	71,12

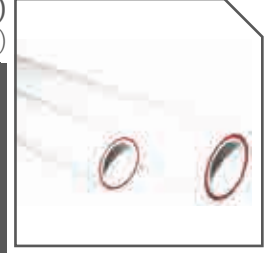

ALUMINIUM FOILED PPR-C PIPES
ALÜMİNYUM FOLYOLU PPR-C BORULAR

PPR-C COMBI PIPE (Aluminium Foil Located in Middle)
KOMBİ BORUSU PPR-C (Ortadan Alüminyum Folyolu)

Code Kod			Diameter Çap (mm)	Bundle Quantity Paket Miktarı (m)	Bundle Dimension Paket Ebatı (cm)	Bundle Weight Paket Ağırlığı (kg)	Price Fiyat (USD)
White Beyaz	Green Yeşil	Grey Gri					
502-630100	730100	830100	20x3.4	100	7x18.5x400	17.70	1,37
502-630102	730102	830102	25x4.2	80	8x18x400	21.50	1,92
502-630104	730104	830104	32x5.4	60	10x19x400	25.98	3,22
502-630106	730106	830106	40x6.7	40	11x21x400	26.62	5,21
502-630108	730108	830108	50x8.3	20	15.5x10.5x400	20.54	7,98
502-630110	730110	830110	63x10.5	16	25x7x400	25.93	12,88



SANICA

PIPE BORU



SANITARY PIPE FITTINGS

SIHHİ TESİSAT BORUSU EK PARÇALARI

90° ELBOW
DİRSEK 90°



Code Kod		Diameter Çap (mm)	Box Quantity Paket Miktarı (pcs)	Box Dimension Paket Ebatı (cm)	Box Weight Paket Ağırlığı (kg)	Price Fiyat (USD)	
White Beyaz	Green Yeşil						Grey Gri
502-600452	700452	800452	20	400	20x40x40	6.295	0,11
502-600454	700454	800454	25	250	20x40x40	6.230	0,18
502-600456	700456	800456	32	150	20x40x40	7.023	0,34
502-600458	700458	800458	40	80	20x40x40	7.527	0,74
502-600460	700460	800460	50	50	20x40x40	7.480	1,35
502-600462	700462	800462	63	25	20x40x40	7.793	2,75
702-600464	700464	800464	75	12	20x40x40	5.530	5,25
702-600466	700466	800466	90	8	20x40x40	6.788	8,75
702-600468	700468	800468	110	5	20x40x40	6.842	18,45

45° ELBOW
DİRSEK 45°



Code Kod		Diameter Çap (mm)	Box Quantity Paket Miktarı (pcs)	Box Dimension Paket Ebatı (cm)	Box Weight Paket Ağırlığı (kg)	Price Fiyat (USD)	
White Beyaz	Green Yeşil						Grey Gri
502-600502	700502	800502	20	500	20x40x40	6.855	0,14
502-600504	700504	800504	25	300	20x40x40	5.955	0,21
502-600506	700506	800506	32	200	20x40x40	7.055	0,33
502-600508	700508	800508	40	100	20x40x40	7.155	0,78
502-600510	700510	800510	50	50	20x40x40	4.930	1,25
502-600512	700512	800512	63	25	20x40x40	6.805	2,56
702-600514	700514	800514	75	16	20x40x40	6.848	5,48
702-600516	700516	800516	90	9	20x40x40	5.517	11,42
702-600518	700518	800518	110	5	20x40x40	5.480	19,12

T PIECE
TE PARÇA



Code Kod		Diameter Çap (mm)	Box Quantity Paket Miktarı (pcs)	Box Dimension Paket Ebatı (cm)	Box Weight Paket Ağırlığı (kg)	Price Fiyat (USD)	
White Beyaz	Green Yeşil						Grey Gri
502-600602	700602	800602	20	300	20x40x40	6.255	0,15
502-600604	700604	800604	25	200	20x40x40	6.455	0,22
502-600606	700606	800606	32	100	20x40x40	6.105	0,48
502-600608	700608	800608	40	50	20x40x40	6.155	0,84
502-600610	700610	800610	50	30	20x40x40	5.775	1,72
502-600612	700612	800612	63	20	20x40x40	7.675	3,41
702-600614	700614	800614	75	12	20x40x40	6.950	6,18
702-600616	700616	800616	90	8	20x40x40	8.380	14,14
702-600618	700618	800618	110	4	20x40x40	6.483	21,65

COUPLING
MANŞON



Code Kod		Diameter Çap (mm)	Box Quantity Paket Miktarı (pcs)	Box Dimension Paket Ebatı (cm)	Box Weight Paket Ağırlığı (kg)	Price Fiyat (USD)	
White Beyaz	Green Yeşil						Grey Gri
502-600702	700702	800702	20	750	20x40x40	7.905	0,09
502-600704	700704	800704	25	400	20x40x40	6.255	0,12
502-600706	700706	800706	32	250	20x40x40	6.480	0,23
502-600708	700708	800708	40	125	20x40x40	6.480	0,39
502-600710	700710	800710	50	75	20x40x40	6.930	0,81
502-600712	700712	800712	63	40	20x40x40	6.895	1,42
702-600714	700714	800714	75	32	20x40x40	7.456	3,15
702-600716	700716	800716	90	20	20x40x40	6.400	5,52
702-600718	700718	800718	110	12	20x40x40	8.420	7,59

SANITARY PIPE FITTINGS

SIHHİ TESİSAT BORUSU EK PARÇALARI



REDUCER
REDÜKSİYON

	Code		Diameter	Box Quantity	Box Dimension	Box Weight	Price
	Kod	Kod					
White Beyaz	Green Yeşil	Grey Gri	(mm)	(m)	(cm)	(kg)	(USD)
502-600752	700752	800752	25-20	600	20x40x40	5.955	0,09
502-600754	700754	800754	32-20	400	20x40x40	7.055	0,15
502-600756	700756	800756	32-25	400	20x40x40	6.255	0,15
502-600758	700758	800758	40-25	200	20x40x40	5.843	0,33
502-600760	700760	800760	40-32	200	20x40x40	6.505	0,38
502-600762	700762	800762	50-32	100	20x40x40	8.055	0,68
502-600764	700764	800764	50-40	100	20x40x40	7.405	0,69
502-600766	700766	800766	63-40	60	20x40x40	8.235	1,12
502-600768	700768	800768	63-50	60	20x40x40	6.855	1,18
702-600770	700770	800770	40-20	350	20x40x40	9.550	2,25
702-600772	700772	800772	50-25	200	20x40x40	8.000	1,28
702-600774	700774	800774	63-32	80	20x40x40	7.208	1,75
702-600776	700776	800776	75-32	50	20x40x40	6.800	2,51
702-600778	700778	800778	75-40	50	20x40x40	6.550	2,51
702-600780	700780	800780	75-50	50	20x40x40	7.300	2,57
702-600782	700782	800782	75-63	40	20x40x40	8.600	2,71
702-600784	700784	800784	90-63	32	20x40x40	8.480	3,57
702-600786	700786	800786	90-75	32	20x40x40	9.792	3,83



INEGAL T
İNEGAL TE

	Code		Diameter	Box Quantity	Box Dimension	Box Weight	Price
	Kod	Kod					
White Beyaz	Green Yeşil	Grey Gri	(mm)	(m)	(cm)	(kg)	(USD)
702-600800	700800	800800	25-20-20	200	20x40x40	7.505	0,24
702-600801	700801	800801	25-25-20	200	20x40x40	6.800	0,25
502-600802	700802	800802	25-20-25	250	20x40x40	6.855	0,25
502-600804	700804	800804	32-20-32	120	20x40x40	6.555	0,45
502-600806	700806	800806	32-25-32	120	20x40x40	5.955	0,45
502-600808	700808	800808	40-32-40	70	20x40x40	6.455	0,97
502-600810	700810	800810	40-25-40	70	20x40x40	6.035	0,89
702-600812	700812	800812	40-20-40	70	20x40x40	5.400	0,87
702-600814	700814	800814	50-20-50	25	20x40x40	7.100	3,09
702-600816	700816	800816	50-25-50	30	20x40x40	8.090	3,09
702-600818	700818	800818	50-32-50	30	20x40x40	6.425	3,09
702-600819	700819	800819	50-40-50	25	20x40x40	6.550	3,09
702-600820	700820	800820	63-20-63	20	20x40x40	8.640	4,99
702-600822	700822	800822	63-25-63	20	20x40x40	8.360	4,99
702-600824	700824	800824	63-32-63	20	20x40x40	8.160	4,99
702-600826	700826	800826	63-40-63	20	20x40x40	8.000	4,99
702-600828	700828	800828	63-50-63	20	20x40x40	7.700	4,99



STOP END
KAPAMA BAŞLIĞI

	Code		Diameter	Box Quantity	Box Dimension	Box Weight	Price
	Kod	Kod					
White Beyaz	Green Yeşil	Grey Gri	(mm)	(m)	(cm)	(kg)	(USD)
502-600902	700902	800902	20	750	20x40x40	6.480	0,09
502-600904	700904	800904	25	500	20x40x40	5.605	0,14
502-600906	700906	800906	32	400	20x40x40	8.055	0,23
502-600908	700908	800908	40	200	20x40x40	7.755	0,38
502-600910	700910	800910	50	100	20x40x40	8.005	0,69
502-600912	700912	800912	63	50	20x40x40	7.005	1,52

BRIDGE (with Coupling)
Köprü (Kavisli)

Code Kod		Diameter Çap (mm)	Box Quantity Paket Miktarı (m)	Box Dimension Paket Ebatı (cm)	Box Weight Paket Ağırlığı (kg)	Price Fiyat (USD)
White Beyaz	Green Yeşil					
502-610102	710102	20	125	20x40x40	5.324	0,46
502-610104	710104	25	90	20x40x40	6.030	0,69
502-610106	710106	32	50	20x40x40	6.280	1,34



SHORT C BRIDGE WITH COUPLING
KAVİSLİ C

Code Kod		Diameter Çap (mm)	Box Quantity Paket Miktarı (m)	Box Dimension Paket Ebatı (cm)	Box Weight Paket Ağırlığı (kg)	Price Fiyat (USD)
White Beyaz	Green Yeşil					
702-610152	710152	20	200	20x40x40	6.055	0,33
702-610154	710154	25	150	20x40x40	6.555	0,52



CHECK VALVE
ÇEKVALF

Code Kod		Diameter Çap (mm)	Box Quantity Paket Miktarı (m)	Box Dimension Paket Ebatı (cm)	Box Weight Paket Ağırlığı (kg)	Price Fiyat (USD)
White Beyaz	Green Yeşil					
702-620940	720940	20	100	20x40x40	10.882	2,42
702-620942	720942	25	100	20x40x40	11.048	2,66



FEMALE NIPPLE
İÇ DİŞLİ NİPEL

Code Kod		Diameter Çap (mm)	Box Quantity Paket Miktarı (m)	Box Dimension Paket Ebatı (cm)	Box Weight Paket Ağırlığı (kg)	Price Fiyat (USD)
White Beyaz	Green Yeşil					
502-610400	710400	20 1/2"	200	20x40x40	8.555	0,91
502-610401	710401	20 3/4"	200	20x40x40	9.455	1,21
502-610402	710402	25 3/4"	200	20x40x40	11.225	1,26
502-610403	710403	25 1/2"	200	20x40x40	11.005	0,96
502-610404	710404	32 1"	100	20x40x40	8.305	2,79
502-610405	710405	32 3/4"	100	20x40x40	7.15	2,76



FEMALE NIPPLE (Hexagon)
İÇ DİŞLİ NİPEL

Code Kod		Diameter Çap (mm)	Box Quantity Paket Miktarı (m)	Box Dimension Paket Ebatı (cm)	Box Weight Paket Ağırlığı (kg)	Price Fiyat (USD)
White Beyaz	Green Yeşil					
502-610406	710406	40 1 1/4"	40	20x40x40	9.375	7,62
502-610407	710407	50 1 1/2"	40	20x40x40	10.695	9,28
502-610408	710408	63 2"	20	20x40x40	11.685	13,36
702-610410	710410	75 2 1/2"	12	20x40x40	11.470	30,36
702-610412	710412	90x3"	12	20x40x40	12.970	43,56





MALE NIPPLE
DIŞ DIŞLİ NİPEL

	Code		Diameter	Box Quantity	Box Dimension	Box Weight	Price
	White Beyaz	Green Yeşil					
502-610500	710500	810500	20 1/2 "	200	20x40x40	10.455	1,19
502-610501	710501	810501	20 3/4"	200	20x40x40	13.455	1,83
502-610502	710502	810502	25 3/4"	200	20x40x40	13.855	1,97
502-610503	710503	810503	25 1/2"	200	20x40x40	12.555	1,31
502-610504	710504	810504	32 1 "	100	20x40x40	10.230	3,31
502-610505	710505	810505	32 3/4"	100	20x40x40	8.655	3,07



MALE NIPPLE (Hexagon)
DIŞ DIŞLİ NİPEL

	Code		Diameter	Box Quantity	Box Dimension	Box Weight	Price
	White Beyaz	Green Yeşil					
502-610506	710506	810506	40 1 1/4"	40	20x40x40	12.375	10,53
502-610507	710507	810507	50 1 1/2"	40	20x40x40	15.055	11,73
502-610508	710508	810508	63 2 "	20	20x40x40	10.675	17,99
702-610510	710510	810510	75 2 1/2"	12	20x40x40	10.122	36,37
702-610512	710512	810512	90 3"	12	20x40x40	13.540	51,48



TRANSITION UNION FEMALE
OYNAR BAŞLI İÇ DIŞLİ REKOR

	Code		Diameter	Box Quantity	Box Dimension	Box Weight	Price
	White Beyaz	Green Yeşil					
502-610600	710600	810600	20 1/2 "	200	20x40x40	13.955	2,38
502-610602	710602	810602	25 3/4"	150	20x40x40	14.655	3,27
502-610604	710604	810604	32 1 "	100	20x40x40	12.925	5,06
502-610606	710606	810606	40 1 1/4"	50	20x40x40	12.430	7,37
502-610608	710608	810608	50 1 1/2"	25	20x40x40	8.849	11,83



TRANSITION UNION MALE
OYNAR BAŞLI DIŞ DIŞLİ REKOR

	Code		Diameter	Box Quantity	Box Dimension	Box Weight	Price
	White Beyaz	Green Yeşil					
502-610700	710700	810700	20 1/2 "	200	20x40x40	14.955	2,72
502-610702	710702	810702	25 3/4"	150	20x40x40	16.305	3,46
502-610704	710704	810704	32 1 "	100	20x40x40	14.025	5,42
502-610706	710706	810706	40 1 1/4"	50	20x40x40	14.480	9,26
502-610708	710708	810708	50 1 1/2"	25	20x40x40	9.524	14,55

90° MALE ELBOW
DIŞ DIŞLI 90° DİRSEK

Code Kod		Diameter Çap (mm)	Box Quantity Paket Miktarı (m)	Box Dimension Paket Ebatı (cm)	Box Weight Paket Ağırlığı (kg)	Price Fiyat (USD)
White Beyaz	Green Yeşil					
502-620100	720100 820100	20 1/2 "	200	20x40x40	13.405	1,26
502-620101	720101 820101	20 3/4"	200	20x40x40	15.805	1,76
502-620102	720102 820102	25 3/4"	150	20x40x40	11.918	2,08
502-620103	720103 820103	25 1/2"	150	20x40x40	11.255	1,82
502-620104	720104 820104	32 1 "	100	20x40x40	12.205	3,51
502-620105	720105 820105	32 3/4"	100	20x40x40	10.575	2,15



FEMALE ELBOW 90°
İÇ DIŞLI 90° DİRSEK

Code Kod		Diameter Çap (mm)	Box Quantity Paket Miktarı (m)	Box Dimension Paket Ebatı (cm)	Box Weight Paket Ağırlığı (kg)	Price Fiyat (USD)
White Beyaz	Green Yeşil					
502-620150	720150 820150	20 1/2 "	200	20x40x40	11.455	0,97
502-620151	720151 820151	20 3/4"	200	20x40x40	13.055	1,36
502-620152	720152 820152	25 3/4"	150	20x40x40	10.080	1,42
502-620153	720153 820153	25 1/2"	150	20x40x40	9.655	1,35
502-620154	720154 820154	32 1 "	100	20x40x40	10.155	2,94
502-620155	720155 820155	32 3/4"	100	20x40x40	9.355	2,02



FEMALE T
İÇ DIŞLI TE

Code Kod		Diameter Çap (mm)	Box Quantity Paket Miktarı (m)	Box Dimension Paket Ebatı (cm)	Box Weight Paket Ağırlığı (kg)	Price Fiyat (USD)
White Beyaz	Green Yeşil					
502-620300	720300 820300	20 1/2 "	200	20x40x40	10.655	1,13
502-620301	720301 820301	20 3/4"	200	20x40x40	11.455	1,54
502-620302	720302 820302	25 3/4"	160	20x40x40	10.775	1,82
502-620303	720303 820303	25 1/2"	160	20x40x40	10.615	1,43
502-620304	720304 820304	32 1 "	80	20x40x40	8.495	3,27
502-620305	720305 820305	32 3/4"	80	20x40x40	8.327	2,22



MALE T
DIŞ DIŞLI TE

Code Kod		Diameter Çap (mm)	Box Quantity Paket Miktarı (m)	Box Dimension Paket Ebatı (cm)	Box Weight Paket Ağırlığı (kg)	Price Fiyat (USD)
White Beyaz	Green Yeşil					
502-620350	720350 820350	20 1/2 "	200	20x40x40	13.855	1,49
502-620351	720351 820351	20 3/4"	200	20x40x40	14.855	1,92
502-620352	720352 820352	25 3/4"	160	20x40x40	12.855	2,51
502-620353	720353 820353	25 1/2"	160	20x40x40	12.215	1,59
502-620354	720354 820354	32 1 "	80	20x40x40	10.935	4,36
502-620355	720355 820355	32 3/4"	80	20x40x40	9.335	3,51



TAP CONNECTION
BATARYA BAĞLANTISI

Code Kod		Diameter Çap (mm)	Box Quantity Paket Miktarı (m)	Box Dimension Paket Ebatı (cm)	Box Weight Paket Ağırlığı (kg)	Price Fiyat (USD)
White Beyaz	Green Yeşil					
502-620400	720400 820400	20 1/2 "	200	20x40x40	11.405	1,12
502-620402	720402 820402	25 3/4"	100	20x40x40	7.355	1,81
502-620404	720404 820404	25 1/2"	100	20x40x40	6.855	1,62





START BUTTERFLY VALVE
KELEBEK BAŞLI VANA

White Beyaz	Code Kod		Diameter Çap (mm)	Box Quantity Paket Miktarı (m)	Box Dimension Paket Ebatı (cm)	Box Weight Paket Ağırlığı (kg)	Price Fiyat (USD)
	Green Yeşil	Grey Gri					
502-620500	720500	820500	20 1/2"	50	20x40x40	7.905	4,42
502-620502	720502	820502	25 3/4"	50	20x40x40	9.643	4,62
702-620504	720504	820504	32 1"	40	20x40x40	11.440	6,37



CHROME PLATED LONG VALVE
KROM LÜKS VANA

White Beyaz	Code Kod		Diameter Çap (mm)	Box Quantity Paket Miktarı (m)	Box Dimension Paket Ebatı (cm)	Box Weight Paket Ağırlığı (kg)	Price Fiyat (USD)
	Green Yeşil	Grey Gri					
502-620850	720850	820850	20	50	20x40x40	14.155	10,03
502-620852	720852	820852	25	50	20x40x40	15.093	10,71



CHROME PLATED HIDDEN VALVE
KROM LÜKS GİZLİ VANA

White Beyaz	Code Kod		Diameter Çap (mm)	Box Quantity Paket Miktarı (m)	Box Dimension Paket Ebatı (cm)	Box Weight Paket Ağırlığı (kg)	Price Fiyat (USD)
	Green Yeşil	Grey Gri					
502-620840	720840	820840	20	50	20x40x40	10.655	9,18
502-620842	720842	820842	25	50	20x40x40	11.743	9,98



BALL VALVE
KÜRESEL VANA

White Beyaz	Code Kod		Diameter Çap (mm)	Box Quantity Paket Miktarı (m)	Box Dimension Paket Ebatı (cm)	Box Weight Paket Ağırlığı (kg)	Price Fiyat (USD)
	Green Yeşil	Grey Gri					
702-620800	720800	820800	20	100	20x40x40	11.555	3,59
702-620802	720802	820802	25	75	20x40x40	11.730	4,98
702-620804	720804	820804	32	50	20x40x40	11.605	7,96
702-620806	720806	820806	40	20	20x40x40	10.755	10,89
702-620808	720808	820808	50	20	20x40x40	15.50	14,42
702-620810	720810	820810	63	15	20x40x40	12.50	23,73
702-620812	720812	820812	75	5	20x40x40	6.90	34,68

NIPPLE WITH LOOSE NUT
OYNAR BAŞLI NİPEL

Code Kod			Diameter Çap (mm)	Box Quantity Paket Miktarı (m)	Box Dimension Paket Ebatı (cm)	Box Weight Paket Ağırlığı (kg)	Price Fiyat (USD)
White Beyaz	Green Yeşil	Grey Gri					
702-620860	720860	820860	20 1/2"	250	20x40x40	16.105	2,43
702-620862	720862	820862	25 3/4"	150	20x40x40	11.805	3,11



ELBOW WITH LOOSE NUT
OYNAR BAŞLI DİRSEK

Code Kod			Diameter Çap (mm)	Box Quantity Paket Miktarı (m)	Box Dimension Paket Ebatı (cm)	Box Weight Paket Ağırlığı (kg)	Price Fiyat (USD)
White Beyaz	Green Yeşil	Grey Gri					
702-620900	720900	820900	20 1/2"	200	20x40x40	9.055	2,75
702-620902	720902	820902	25 3/4"	150	20x40x40	8.505	3,11



SINGLE CLAMP
TEKLE KELEPÇE

Code Kod			Diameter Çap (mm)	Box Quantity Paket Miktarı (m)	Box Dimension Paket Ebatı (cm)	Box Weight Paket Ağırlığı (kg)	Price Fiyat (USD)
White Beyaz	Green Yeşil	Grey Gri					
502-620600	720600	820600	20	1250	20x40x40	5.480	0,07
502-620602	720602	820602	22	1250	20x40x40	5.855	0,07
502-620604	720604	820604	25	750	20x40x40	5.505	0,08
502-620606	720606	820606	27	750	20x40x40	5.655	0,08
502-620608	720608	820608	32	500	20x40x40	5.355	0,12
502-620610	720610	820610	34	500	20x40x40	5.605	0,12
502-620612	720612	820612	40	400	20x40x40	4.855	0,14
502-620614	720614	820614	50	300	20x40x40	5.505	0,33
502-620616	720616	820616	63	200	20x40x40	5.855	0,51



DOUBLE CLAMP
ÇİFTLİ KELEPÇE

Code Kod			Diameter Çap (mm)	Box Quantity Paket Miktarı (m)	Box Dimension Paket Ebatı (cm)	Box Weight Paket Ağırlığı (kg)	Price Fiyat (USD)
White Beyaz	Green Yeşil	Grey Gri					
502-620650	720650	820650	20	600	20x40x40	4.755	0,11
502-620652	720652	820652	25	500	20x40x40	5.605	0,13
502-620654	720654	820654	32	300	20x40x40	5.655	0,21



SANITARY PIPE FITTINGS

SIHHİ TESİSAT BORUSU EK PARÇALARI



STOP END THREADED
KÖR TAPA

White Beyaz	Code Kod		Diameter Çap (mm)	Box Quantity Paket Miktarı (m)	Box Dimension Paket Ebatı (cm)	Box Weight Paket Ağırlığı (kg)	Price Fiyat (USD)
	Green Yeşil	Grey Gri					
502-620550	720550	820550	20 1/2"	1000	20x40x40	6.355	0,09
502-620552	720552	820552	25 3/4"	750	20x40x40	5.355	0,12
502-620554	720554	820554	32 1"	400	20x40x40	6.255	0,15



FILTER
SÜZGEÇ

White Beyaz	Code Kod		Diameter Çap (mm)	Box Quantity Paket Miktarı (m)	Box Dimension Paket Ebatı (cm)	Box Weight Paket Ağırlığı (kg)	Price Fiyat (USD)
	Green Yeşil	Grey Gri					
702-620930	720930	820930	20	200	20x40x40	13.455	3,03
702-620932	720932	820932	25	150	20x40x40	13.555	3,14



DOUBLE TAP CONNECTION
İKİLİ BATARYA BAĞLANTISI

White Beyaz	Code Kod		Diameter Çap (mm)	Box Quantity Paket Miktarı (m)	Box Dimension Paket Ebatı (cm)	Box Weight Paket Ağırlığı (kg)	Price Fiyat (USD)
	Green Yeşil	Grey Gri					
702-620980	720980	820980	20 1/2"	50	20x40x40	7.405	3,62
702-620982	720982	820982	25 1/2"	50	20x40x40	7.555	3,89



ADJUSTABLE TAP CONNECTION
AYARLANABİLİR BATARYA

White Beyaz	Code Kod		Diameter Çap (mm)	Box Quantity Paket Miktarı (m)	Box Dimension Paket Ebatı (cm)	Box Weight Paket Ağırlığı (kg)	Price Fiyat (USD)
	Green Yeşil	Grey Gri					
702-620990	720990	820990	20 1/2"	25	20x40x40	6.530	4,85
702-620992	720992	820992	25 1/2"	25	20x40x40	6.080	4,98

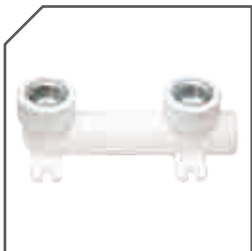

BIDET TAP CONNECTION
TAHARET BATARYASI

White Beyaz	Code Kod		Diameter Çap (mm)	Box Quantity Paket Miktarı (m)	Box Dimension Paket Ebatı (cm)	Box Weight Paket Ağırlığı (kg)	Price Fiyat (USD)
	Green Yeşil	Grey Gri					
702-620994	720994	820994	20 1/2"	70	20x40x40	3.380	3,02

VALVE IN THE FILTER COMPOSITE STRUCTURES
BİRLEŞİK YAPIDA SÜZGEÇ VE VANA

TIME SAVER
ZAMANDAN TASARRUF

EASY INSTALLATION
KOLAY MONTAJ

WITHOUT CAUSING LOSS OF FLOW COMPLETE TRANSITION
DEBİ KAYBINA NEDEN OLMAYAN TAM GEÇİŞ



EXTRA GAS BOILER INSTALLATION SET (Nipple)
EXTRA KOMBİ BAĞLANTI SETİ (Nipelili)

Code Kod	Diameter Çap (mm)	Box Quantity Paket Miktarı (pcs)	Box Dimension Paket Ebatı (cm)	Box Weight Paket Ağırlığı (kg)	Price Fiyat (USD)
702-620710 (6 pcs)	20-25	18	18x12x12	0.720	30,22



EXTRA GAS BOILER INSTALLATION SET (Elbow)
EXTRA KOMBİ BAĞLANTI SETİ (Dirseklili)

Code Kod	Diameter Çap (mm)	Box Quantity Paket Miktarı (pcs)	Box Dimension Paket Ebatı (cm)	Box Weight Paket Ağırlığı (kg)	Price Fiyat (USD)
702-620711 (6 pcs)	20-25	18	18x12x12	0.780	30,22

GAS BOILER INSTALLATION SET (Nipple)
KOMBİ BAĞLANTI SETİ (Nipelili)

Code Kod	Diameter Çap (mm)	Box Quantity Paket Miktarı (pcs)	Box Dimension Paket Ebatı (cm)	Box Weight Paket Ağırlığı (kg)	Price Fiyat (USD)
702-620700 (8 pcs)	20-25	18	18x12x12	0.800	30,22
702-620701 (10 pcs)	20-25	18	18x12x12	1.050	34,22



GAS BOILER INSTALLATION SET (Elbow)
KOMBİ BAĞLANTI SETİ (Dirseklili)

Code Kod	Diameter Çap (mm)	Box Quantity Paket Miktarı (pcs)	Box Dimension Paket Ebatı (cm)	Box Weight Paket Ağırlığı (kg)	Price Fiyat (USD)
702-620702 (8 pcs)	20-25	18	18x12x12	0.800	30,22
702-620703 (10 pcs)	20-25	18	18x12x12	1.100	34,22



WELDING MACHINE (Round)
KAYNAK MAKİNASI (Yuvarlak)

Code Kod	Diameter Çap (mm)	Box Quantity Paket Miktarı (pcs)	Box Dimension Paket Ebatı (cm)	Box Weight Paket Ağırlığı (kg)	Price Fiyat (USD)
702-620780	-	1	31x47x10	2.50	99,85



WELDING MACHINE
KAYNAK MAKİNASI

Code Kod	Diameter Çap (mm)	Box Quantity Paket Miktarı (pcs)	Box Dimension Paket Ebatı (cm)	Box Weight Paket Ağırlığı (kg)	Price Fiyat (USD)
702-620782	20-40	1	31x47x10	5.72	89,55



PIPE SCISSORS
BORU MAKASI

Code Kod	Diameter Çap (mm)	Box Quantity Paket Miktarı (pcs)	Box Dimension Paket Ebatı (cm)	Box Weight Paket Ağırlığı (kg)	Price Fiyat (USD)
702-720780	20-40	5	14x27x12	0.5	16,67



WELDING APPARATUS
KAYNAK PAFTASI

Code Kod	Diameter Çap (mm)	Box Quantity Paket Miktarı (pcs)	Box Dimension Paket Ebatı (cm)	Box Weight Paket Ağırlığı (kg)	Price Fiyat (USD)
702-720750	20	1	-	0.093	4,75
702-720752	25	1	-	0.118	5,23
702-720754	32	1	-	0.188	6,22
702-720756	40	1	-	0.267	8,18
702-720758	50	1	-	0.396	14,52
702-720760	63	1	-	0.746	26,83
702-720762	75	1	-	1.365	35,83
702-720764	90	1	-	2.440	44,33
702-720766	110	1	-	2.700	51,67
702-720768	125	1	-	2.850	61,11



SANICA

PIPE BORU

**INDOOR HEATING SYSTEMS
PEX - AL-PEX PIPES and FITTINGS**

BİNA İÇİ ISITMA SİSTEMLERİ
PEX - AL - PEX BORULAR VE
EK PARÇALARI



PEX - AL-PEX PIPE

PEX - AL-PEX BORU

Code Kod	Diameter Çap (mm)	Bundle Quantity Paket Miktarı (m)	Bundle Dimension Paket Ebatı (cm)	Bundle Weight Paket Ağırlığı (kg)	Price Fiyat (USD)
502-1001620	16x2.0	200	70x25	20.4	1,18
502-1001621	16x2.0	100	70x22	10.2	1,18
502-1001820	18x2,0	100	70x23	11,5	1,72
502-1002020	20x2.0	100	70x25	14.00	1,88
502-1002525	25x2.5	100	70x25	20.10	3,26
502-1002630	26x3.0	100	70x25	23.91	3,98
502-1003230	32x3.0	50	75x25	15.50	7,65



PPR-C FLOOR HEATING PIPE

PPR-C YERDEN ISITMA BORUSU

Code Kod	Diameter Çap (mm)	Bundle Quantity Paket Miktarı (m)	Bundle Dimension Paket Ebatı (cm)	Bundle Weight Paket Ağırlığı (kg)	Price Fiyat (USD)
502-000172080	17 x 2	80	70 x 25	7	0,68
502-000172100	17 x 2	100	73 x 25	10.5	0,68
502-000172160	17 x 2	160	76 x 25	14	0,68



PEX-B PIPE

PEX-B BORU

Code Kod	Diameter Çap (mm)	Bundle Quantity Paket Miktarı (m)	Bundle Dimension Paket Ebatı (cm)	Bundle Weight Paket Ağırlığı (kg)	Price Fiyat (USD)
502-0X 162100	16x2	100	70x22	8.75	0,71
502-0X 162	16x2	160	70x22	14	0,71
502-0X 162200	16x2	200	70x22	17.5	0,71
502-0X 1622100	16x2.2	100	70x22	10.6	0,79
502-0X 1622	16x2.2	160	70x22	17	0,79
502-0X 182100	18x2	100	70x22	11.8	1,02
502-0X 182	18x2	160	70x22	19	1,02
502-0X 202100	20x2	100	70x22	13.3	1,19
502-0X 202	20x2	160	70x22	21.4	1,19
502-0X 202200	20x2	200	70x22	26.6	1,19



PERT PIPE

PERT BORU

Code Kod	Diameter Çap (mm)	Box Quantity Paket Miktarı (m)	Box Dimension Paket Ebatı (cm)	Box Weight Paket Ağırlığı (kg)	Price Fiyat (USD)
502-1162100	16x2	100	70x22	14.6	1,06



PEX-B OXYGEN BARRIER PIPE

PEX-B OKSİJEN BARİYERLİ BORU

Code Kod	Diameter Çap (mm)	Box Quantity Paket Miktarı (m)	Box Dimension Paket Ebatı (cm)	Box Weight Paket Ağırlığı (kg)	Price Fiyat (USD)
502-XO 162100	16 x 2	100	70x22	9	0,89
502-XO 162160	16 x 2	160	70x22	14.4	0,89
502-XO162200	16 x 2	200	70x22	18	0,89

PEX-B PIPE WITH SPIRAL COATED PIPE
PEX - B KILIFLI BORU

Code Kod	Diameter Çap (mm)	Bundle Quantity Paket Miktarı (m)	Bundle Dimension Paket Ebatı (cm)	Bundle Weight Paket Ağırlığı (kg)	Price Fiyat (USD)
502-XM 162100	16 x 2	100	70x22	14.6	1,01
502-XK 162100	16 x 2	100	70x22	14.6	1,01

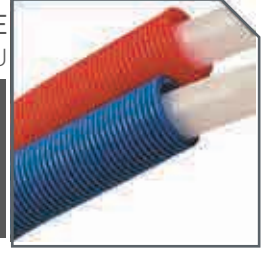

PEX-B OXYGEN BARRIER WITH SPIRAL COATED PIPE
PEX-B OKSİJEN BARIYERLİ KILIFLI BORU

Code Kod	Diameter Çap (mm)	Box Quantity Paket Miktarı (m)	Box Dimension Paket Ebatı (cm)	Box Weight Paket Ağırlığı (kg)	Price Fiyat (USD)
502-XOM 162100	16 x 2	100	70x22	14.6	1,22
502-XOK 162100	16 x 2	100	70x22	14.6	1,22



PERT WITH SPIRAL COATED PIPE
PERT KILIFLI BORU

Kod Code	Çap Diameter (mm)	Paket Miktarı Box Quantity (m)	Paket Ebatı Box Dimension (cm)	Paket Ağırlığı Box Weight (kg)	Fiyat Price (USD)
502-KKT1162100	16x2	100	70x22	14.6	1,10
502-KMT1162100	16x2	100	70x22	14.6	1,10



SPIRAL PIPE
KILIF BORU

Code Kod	Diameter Çap (mm)	Box Quantity Paket Miktarı (m)	Box Dimension Paket Ebatı (cm)	Box Weight Paket Ağırlığı (kg)	Price Fiyat (USD)
702-K 162	25	100	56x20	5.60	0,38
702-M 162	25	100	56x20	5.60	0,38

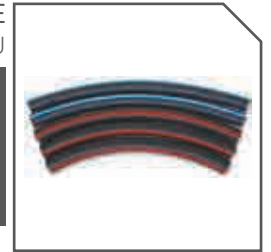

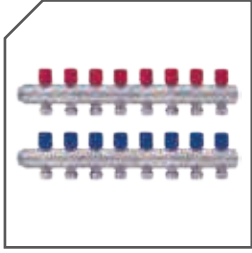

COLLECTOR
KOLLEKTÖR

Code Kod	Diameter Çap (mm)	Box Quantity Paket Miktarı (pcs)	Box Dimension Paket Ebatı (cm)	Box Weight Paket Ağırlığı (kg)	Price Fiyat (USD)
702-162400	2 x 16 x 2	2	-	1.004	15,35
702-162402	3 x 16 x 2	2	-	1.432	23,07
702-162403	4 x 16 x 2	2	-	1.888	30,76
702-162404	5 x 16 x 2	2	-	2.338	38,47
702-162405	6 x 16 x 2	2	-	2.788	46,13
702-162406	7 x 16 x 2	2	-	3.268	53,82
702-162408	8 x 16 x 2	2	-	3.708	61,51
702-162410	9 x 16 x 2	2	-	4.18	69,19
702-162412	10 x 16 x 2	2	-	4.592	76,89
702-162414	11 x 16 x 2	2	-	5.05	89,26
702-162416	12 x 16 x 2	2	-	5.51	97,36

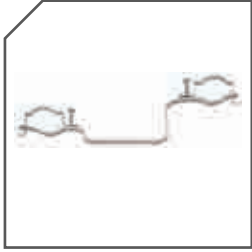

COLLECTOR CLAMP
KOLLEKTÖR KELEPÇESİ

Code Kod	Diameter Çap (mm)	Box Quantity Paket Miktarı (pcs)	Box Dimension Paket Ebatı (cm)	Box Weight Paket Ağırlığı (kg)	Price Fiyat (USD)
702-001621	5	70	20x40x40	10	1,93



COLLECTOR CABIN
KOLLEKTÖR DOLABI

Code Kod	Diameter Çap (mm)	Box Quantity Paket Miktarı (m)	Box Dimension Paket Ebatı (cm)	Box Weight Paket Ağırlığı (kg)	Price Fiyat (USD)
702-12630400	40x10x60	1	-	-	47,29
702-12630500	50x10x60	1	-	-	55,37
702-12630600	60x10x60	1	-	-	63,34
702-12630700	70x10x60	1	-	-	72,34
702-12630800	80x10x60	1	-	-	77,42
702-12630900	90x10x60	1	-	-	78,78
702-12631000	100x10x60	1	-	-	90,83



COLLECTOR CABIN LUXURY
KOLLEKTÖR DOLABI LÜKS

Code Kod	Diameter Çap (mm)	Box Quantity Paket Miktarı (m)	Box Dimension Paket Ebatı (cm)	Box Weight Paket Ağırlığı (kg)	Price Fiyat (USD)
702-12630401	40x10x60	1	-	-	68,35
702-12630501	50x10x60	1	-	-	76,18
702-12630601	60x10x60	1	-	-	83,74
702-12630701	70x10x60	1	-	-	95,98
702-12630801	80x10x60	1	-	-	108,61
702-12630901	90x10x60	1	-	-	118,96
702-12631001	100x10x60	1	-	-	132,62

AL-PEX ELBOW 90°
90° AL-PEX DİRSEK

Code Kod	Diameter Çap (mm)	Box Quantity Paket Miktarı (m)	Price Fiyat (USD)
702-0201160	16x16x2	200	4,89
702-0202200	20x20x2	150	5,22



AL-PEX T
AL-PEX TE

Code Kod	Diameter Çap (mm)	Box Quantity Paket Miktarı (m)	Price Fiyat (USD)
702-0301160	16x16x16x2	120	6,24
702-0302200	20x20x20x2	84	6,61



AL-PEX INEGAL T
AL-PEX İNEGAL TE

Code Kod	Diameter Çap (mm)	Box Quantity Paket Miktarı (m)	Price Fiyat (USD)
702-0402160	20x16x20x2	100	6,58
702-0401200	16x20x16x2	100	6,61



AL-PEX REDUCER T
AL-PEX REDÜKSİYON TE

Code Kod	Diameter Çap (mm)	Box Quantity Paket Miktarı (m)	Price Fiyat (USD)
702-0501160	20x16x16x2	100	6,48
702-0502200	20x20x16x2	100	6,49



AL-PEX REDUCER
AL-PEX REDÜKSİYON

Code Kod	Diameter Çap (mm)	Box Quantity Paket Miktarı (m)	Price Fiyat (USD)
702-0601160	20x16x2	200	4,71



AL-PEX COUPLING
AL-PEX MANŞON

Code Kod	Diameter Çap (mm)	Box Quantity Paket Miktarı (m)	Price Fiyat (USD)
702-0701160	16x16x2	250	4,07
702-0702200	20x20x2	200	4,82



FITTINGS FOR INDOOR HEATING SYSTEMS

BİNA İÇİ ISITMA SİSTEMLERİ EK PARÇALARI



AL-PEX FEMALE NIPPLE
AL-PEX İÇ DİŞLİ NİPEL

Code Kod	Diameter Çap (mm)	Box Quantity Paket Miktarı (pcs)	Price Fiyat (USD)
702-0801160	16x1/2x2	250	3,97
702-0802200	20x1/2x2	200	4,12
702-0803340	20x3 4x3	150	5,32



AL-PEX MALE NIPPLE
AL-PEX DIŞ DİŞLİ NİPEL

Code Kod	Diameter Çap (mm)	Box Quantity Paket Miktarı (pcs)	Price Fiyat (USD)
702-0901160	16x1/2x2	300	3,79
702-0902200	20x1/2x2	200	3,77
702-0903340	20x3 4x3	200	4,63



AL-PEX FEMALE T
AL-PEX İÇ DİŞ TE

Code Kod	Diameter Çap (mm)	Box Quantity Paket Miktarı (pcs)	Price Fiyat (USD)
702-0110116	16x1/2x16x2	100	6,16
702-0110220	20x1/2x20x2	100	6,19



AL-PEX MALE T
AL-PEX DIŞ DİŞ TE

Code Kod	Diameter Çap (mm)	Box Quantity Paket Miktarı (pcs)	Price Fiyat (USD)
702-0120116	16x1/2x16x2	100	6,58
702-0120220	20x1/2x20x2	100	6,61



AL-PEX FEMALE ELBOW
AL-PEX İÇ DİŞ DİRSEK

Code Kod	Diameter Çap (mm)	Box Quantity Paket Miktarı (pcs)	Price Fiyat (USD)
702-0130116	16x1/2x2	200	4,68
702-0130220	20x1/2x2	150	4,71



MALE ELBOW
AL-PEX DIŞ DİŞ DİRSEK

Code Kod	Diameter Çap (mm)	Box Quantity Paket Miktarı (pcs)	Price Fiyat (USD)
702-0140116	16x1/2x2	200	5,22
702-0140220	20x1/2x2	150	5,25



AL-PEX STOP END
AL-PEX KÖRTAPA

Code Kod	Diameter Çap (mm)	Box Quantity Paket Miktarı (m)	Price Fiyat (USD)
702-0150116	16x2	250	3,23
702-0150220	20x2	200	3,69

CORNER RADIATOR VALVE
KÖŞE RADYATÖR VANASI

Code Kod	Diameter Çap (mm)	Box Quantity Paket Miktarı (pcs)	Box Dimension Paket Ebatı (cm)	Box Weight Paket Ağırlığı (kg)	Price Fiyat (USD)
702-162320	1/2"	70	35x20x20	11.00	6,04



STRAIGHT RADIATOR VALVE
DÜZ RADYATÖR VANASI

Code Kod	Diameter Çap (mm)	Box Quantity Paket Miktarı (pcs)	Box Dimension Paket Ebatı (cm)	Box Weight Paket Ağırlığı (kg)	Price Fiyat (USD)
702-162323	1/2"	70	35x20x20	13.50	7,25



PEX CORNER RADIATOR VALVE
PEX KÖŞE RADYATÖR VANASI

Code Kod	Diameter Çap (mm)	Box Quantity Paket Miktarı (pcs)	Box Dimension Paket Ebatı (cm)	Box Weight Paket Ağırlığı (kg)	Price Fiyat (USD)
702-162321	1/2" 16x2	70	35x20x20	12.50	7,14



PEX STRAIGHT RADIATOR VALVE
PEX DÜZ RADYATÖR VANASI

Code Kod	Diameter Çap (mm)	Box Quantity Paket Miktarı (pcs)	Box Dimension Paket Ebatı (cm)	Box Weight Paket Ağırlığı (kg)	Price Fiyat (USD)
702-162325	1/2" 16x2	70	35x20x20	14.50	8,12



MINI COMPRESSION COUPLING
MİNİ REKOR

Code Kod	Diameter Çap (mm)	Box Quantity Paket Miktarı (pcs)	Box Dimension Paket Ebatı (cm)	Box Weight Paket Ağırlığı (kg)	Price Fiyat (USD)
702-162202	16	250	35x20x20	16.25	2,22



EXTENDED PIPE CONNECTION COMPRESSION COUPLING
UZATMA ÇUBUĞU BAĞLANTI REKORU

Code Kod	Diameter Çap (mm)	Box Quantity Paket Miktarı (pcs)	Box Dimension Paket Ebatı (cm)	Box Weight Paket Ağırlığı (kg)	Price Fiyat (USD)
702-162302	16	250	35x20x20	24.50	2,97



COUPLING WITH NIPPLE
REKORLU NİPEL

Code Kod	Diameter Çap (mm)	Box Quantity Paket Miktarı (pcs)	Box Dimension Paket Ebatı (cm)	Box Weight Paket Ağırlığı (kg)	Price Fiyat (USD)
702-162304 Outlet - Çıkış	1/2"	250	35x20x20	15.20	2,15
702-162306 Inlet - Giriş	16x2	250	35x20x20	17.21	2,18



FITTINGS FOR INDOOR HEATING SYSTEMS

BİNA İÇİ ISITMA SİSTEMLERİ EK PARÇALARI



CORNER RADIATOR COUPLING
KÖŞE RADYATÖR MANŞON

Code Kod	Diameter Çap (mm)	Box Quantity Paket Miktarı (pcs)	Box Dimension Paket Ebatı (cm)	Box Weight Paket Ağırlığı (kg)	Price Fiyat (USD)
702-162322	1/2"	50	35x20x20	13.70	4,72



INLET - OUTLET VALVE
ALTTAN GİRİŞ - ÇIKIŞ VANASI

Code Kod	Diameter Çap (mm)	Box Quantity Paket Miktarı (pcs)	Box Dimension Paket Ebatı (cm)	Box Weight Paket Ağırlığı (kg)	Price Fiyat (USD)
702-162324	1/2"	25	35x20x20	6.85	6,57

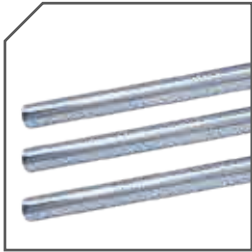

CHROME PLATED BRASS EXTENSION PIPE
KROM KAPLI PİRİNÇ UZATMA BORUSU

Code Kod	Diameter Çap (mm)	Box Quantity Paket Miktarı (pcs)	Box Dimension Paket Ebatı (cm)	Box Weight Paket Ağırlığı (kg)	Price Fiyat (USD)
702-162310	15	100	-	5.75	1,96
702-162311	45	50	-	5.00	4,83
702-162312	60	50	-	11.47	7,05
702-162313	90	50	-	17.24	10,48



CORNER CORRECTIVE
KÖŞE DÜZELTİCİ

Code Kod	Diameter Çap (mm)	Box Quantity Paket Miktarı (pcs)	Box Dimension Paket Ebatı (cm)	Box Weight Paket Ağırlığı (kg)	Price Fiyat (USD)
702-001616	16	150	60x40x40	14.50	0,33

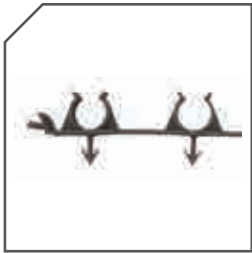

CUTTING EDGE WITH CLIP
KLİPSLİ LAMA

Code Kod	Diameter Çap (mm)	Box Quantity Paket Miktarı (pcs)	Box Dimension Paket Ebatı (cm)	Box Weight Paket Ağırlığı (kg)	Price Fiyat (USD)
702-001617	16	400	60x40x40	12.50	0,35



PIPE HOLDER
BORU TUTUCU

Code Kod	Diameter Çap (mm)	Box Quantity Paket Miktarı (pcs)	Box Dimension Paket Ebatı (cm)	Box Weight Paket Ağırlığı (kg)	Price Fiyat (USD)
702-001620	25	10.000	Sack Çuval	15.50	0,02



WALL PLUG FOR FLOOR
YERE TESPİT DUBELİ

Code Kod	Diameter Çap (mm)	Box Quantity Paket Miktarı (pcs)	Box Dimension Paket Ebatı (cm)	Box Weight Paket Ağırlığı (kg)	Price Fiyat (USD)
702-001618	16	7.500	Sack Çuval	13.75	0,03
702-001619	25	5.000	Sack Çuval	18.30	0,04

SANICA

PIPE BORU



PVC WASTE WATER PIPES and FITTINGS

ATIK SU BORULARI ve EK PARÇALARI

PVC WASTE WATER PIPES

PVC ATIK SU BORULARI

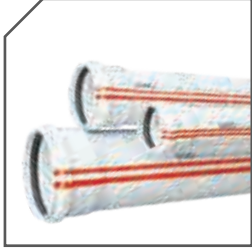

PVC WASTE WATER PIPE TYPE 1 (3.2 mm)

PVC ATIK SU BORUSU TİP 1 (3.2 mm)

Code Kod	Diameter/Lenght Çap / Boy (mm)	Thickness Et Kalınlığı (mm)	Bundle / Sack Quantity Paket Miktarı (pcs)	Packing Type Ambalaj Tipi	Price/pcs Fiyat/boy (USD)
503-032000	50/150	3.0	150	Sack Çuval	0,71
503-032002	50/250	3.0	100	Sack Çuval	0,84
503-032004	50/500	3.0	50	Sack Çuval	1,17
503-032006	50/1000	3.0	5	Bundle Bağ	2,02
503-032008	50/2000	3.0	5	Bundle Bağ	3,99
503-032010	50/3000	3.0	5	Bundle Bağ	5,89
503-032012	50/6000	3.0	5	Bundle Bağ	11,41
503-032014	75/150	3.0	70	Sack Çuval	0,98
503-032016	75/250	3.0	50	Sack Çuval	1,49
503-032018	75/500	3.0	25	Sack Çuval	1,93
503-032020	75/1000	3.0	5	Bundle Bağ	3,63
503-032022	75/2000	3.0	5	Bundle Bağ	6,81
503-032024	75/3000	3.0	5	Bundle Bağ	9,78
503-032026	75/6000	3.0	5	Bundle Bağ	19,84
503-032028	110/150	3.2	35	Sack Çuval	1,67
503-032030	110/250	3.2	25	Sack Çuval	2,24
503-032032	110/500	3.2	12	Sack Çuval	3,08
503-032034	110/1000	3.2	3	Bundle Bağ	5,42
503-032036	110/2000	3.2	3	Bundle Bağ	10,21
503-032038	110/3000	3.2	3	Bundle Bağ	14,63
503-032040	110/6000	3.2	3	Bundle Bağ	30,12
503-032042	125/150	3.2	25	Sack Çuval	2,08
503-032044	125/250	3.2	15	Sack Çuval	2,62
503-032046	125/500	3.2	10	Sack Çuval	4,35
503-032048	125/1000	3.2	3	Bundle Bağ	7,56
503-032050	125/2000	3.2	3	Bundle Bağ	14,13
503-032052	125/3000	3.2	3	Bundle Bağ	20,91
503-032054	125/6000	3.2	3	Bundle Bağ	43,98
503-032056	160/150	4.0	15	Sack Çuval	3,11
503-032058	160/250	4.0	9	Sack Çuval	4,23
503-032060	160/500	4.0	5	Sack Çuval	4,59
503-032062	160/1000	4.0	3	Bundle Bağ	11,28
503-032064	160/2000	4.0	3	Bundle Bağ	21,32
503-032066	160/3000	4.0	3	Bundle Bağ	31,51
503-032068	160/6000	4.0	1	Bundle Bağ	62,16
503-032070	200/150	4.9	10	Bundle Bağ	5,22
503-032072	200/250	4.9	8	Bundle Bağ	6,72
503-032074	200/500	4.9	2	Bundle Bağ	14,57
503-032076	200/1000	4.9	1	Bundle Bağ	18,35
503-032078	200/2000	4.9	1	Bundle Bağ	34,56
503-032080	200/3000	4.9	1	Bundle Bağ	51,02
503-032082	200/6000	4.9	1	Bundle Bağ	100,67

PVC WASTE WATER PIPE TYPE 2 (2.2 mm)
PVC ATIK SU BORUSU TIP 2 (2.2 mm)

Code Kod	Diameter/Lenght Çap / Boy (mm)	Thickness Et Kalınlığı (mm)	Bundle / Sack Quantity Paket Miktarı (pcs)	Packing Type Ambalaj Tipi	Price/pcs Fiyat/boy (USD)
503-022000	50/150	1.8	150	Sack Çuval	0,39
503-022002	50/250	1.8	100	Sack Çuval	0,54
503-022004	50/500	1.8	50	Sack Çuval	0,81
503-022006	50/1000	1.8	5	Bundle Bağ	1,43
503-022008	50/2000	1.8	5	Bundle Bağ	2,69
503-022010	50/3000	1.8	5	Bundle Bağ	4,14
503-022012	50/6000	1.8	5	Bundle Bağ	8,22
503-022014	75/150	1.8	70	Sack Çuval	0,84
503-022016	75/250	1.8	50	Sack Çuval	0,96
503-022018	75/500	1.8	25	Sack Çuval	1,27
503-022020	75/1000	1.8	5	Bundle Bağ	2,28
503-022022	75/2000	1.8	5	Bundle Bağ	4,37
503-022024	75/3000	1.8	5	Bundle Bağ	6,49
503-022026	75/6000	1.8	5	Bundle Bağ	12,99
503-022028	110/150	2.2	35	Sack Çuval	1,17
503-022030	110/250	2.2	25	Sack Çuval	1,59
503-022032	110/500	2.2	12	Sack Çuval	2,12
503-022034	110/1000	2.2	3	Bundle Bağ	3,66
503-022036	110/2000	2.2	3	Bundle Bağ	7,13
503-022038	110/3000	2.2	3	Bundle Bağ	10,05
503-022040	110/6000	2.2	3	Bundle Bağ	20,67
503-022042	125/150	2.5	25	Sack Çuval	1,29
503-022044	125/250	2.5	15	Sack Çuval	1,78
503-022046	125/500	2.5	10	Sack Çuval	3,17
503-022048	125/1000	2.5	3	Bundle Bağ	5,58
503-022050	125/2000	2.5	3	Bundle Bağ	10,62
503-022052	125/3000	2.5	3	Bundle Bağ	15,66
503-022054	125/6000	2.5	3	Bundle Bağ	30,44
503-022056	160/150	3.2	15	Sack Çuval	2,24
503-022058	160/250	3.2	9	Sack Çuval	3,51
503-022060	160/500	3.2	5	Sack Çuval	5,01
503-022062	160/1000	3.2	3	Bundle Bağ	8,79
503-022064	160/2000	3.2	3	Bundle Bağ	17,23
503-022066	160/3000	3.2	3	Bundle Bağ	27,46
503-022068	160/6000	3.2	1	Bundle Bağ	44,19
503-022070	200/150	3.9	10	Bundle Bağ	3,52
503-022072	200/250	3.9	8	Bundle Bağ	4,27
503-022074	200/500	3.9	2	Bundle Bağ	9,34
503-022076	200/1000	3.9	1	Bundle Bağ	15,38
503-022078	200/2000	3.9	1	Bundle Bağ	30,99
503-022080	200/3000	3.9	1	Bundle Bağ	39,57
503-022082	200/6000	3.9	1	Bundle Bağ	78,02

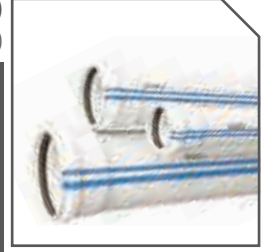

PVC WASTE WATER PIPE FITTINGS

PVC ATIK SU BORUSU EK PARÇALARI



45° ELBOW
DİRSEK 45°

Code Kod	Diameter Çap (mm)	Sack Quantity Çuval Miktarı (pcs)	Price Fiyat (USD)
503-032200	50x45	200	0,39
503-032202	75x45	125	0,74
503-032204	110x45	40	1,33
503-032206	125x45	25	2,05
503-032208	160x45	15	4,49
503-032210	200x45	8	15,22



87° ELBOW
DİRSEK 87°

Code Kod	Diameter Çap (mm)	Sack Quantity Çuval Miktarı (pcs)	Price Fiyat (USD)
503-032224	50x87	200	0,57
503-032226	75x87	100	0,98
503-032228	110x87	30	1,77
503-032230	125x87	20	2,59
503-032232	160x87	10	5,98
503-032234	200x87	4	19,42



45° SINGLE BRANCH
TEK ÇATAL 45°

Code Kod	Diameter Çap (mm)	Sack Quantity Çuval Miktarı (pcs)	Price Fiyat (USD)
503-032250	50x50x45	100	0,86
503-032252	75x50x45	50	1,18
503-032254	75x75x45	30	1,78
503-032256	110x50x45	30	1,98
503-032258	110x75x45	25	2,82
503-032260	110x110x45	15	3,46
503-032262	125x110x45	10	5,81
503-032264	125x125x45	10	7,07
503-032266	160x110x45	5	8,74
503-032268	160x125x45	8	9,94
503-032270	160x160x45	5	13,71
503-032272	200x110x45	5	17,45
702-032274	200x125x45	5	25,53
503-032276	200x160x45	4	27,68
503-032278	200x200x45	4	31,43

87° T BRANCH
TE ÇATAL 87°



Code Kod	Diameter Çap (mm)	Sack Quantity Çuval Miktarı (pcs)	Price Fiyat (USD)
503-032300	50x50x87	100	0,85
503-032302	75x50x87	50	1,29
503-032304	75x75x87	50	1,61
503-032306	110x50x87	30	1,91
503-032308	110x75x87	25	2,82
503-032310	110x110x87	20	3,03
503-032312	125x110x87	10	5,29
503-032314	125x125x87	10	6,14
503-032316	160x110x87	5	8,69
702-032318	160x125x87	5	9,72
503-032320	160x160x87	5	12,53
702-032322	200x110x87	5	19,57
702-032324	200x160x87	5	25,53
702-032326	200x200x87	4	34,35

45° DOUBLE BRANCH
ÇİFT ÇATAL 45°



Code Kod	Diameter Çap (mm)	Sack Quantity Çuval Miktarı (pcs)	Price Fiyat (USD)
503-032350	50x50x45	75	1,52
503-032352	75x50x45	50	2,13
503-032354	75x75x45	25	3,63
503-032356	110x50x45	10	4,54
503-032358	110x110x45	10	5,67

87° CROSS T
İSTAVROZ TE ÇATAL 87°



Code Kod	Diameter Çap (mm)	Sack Quantity Çuval Miktarı (pcs)	Price Fiyat (USD)
503-032370	110x50x87	10	3,52
503-032372	110x110x87	10	7,37
702-032374	50x50x87	10	3,93
702-032376	75x75x87	10	4,09

REDUCING SOCKET
REDÜKSİYON



Code Kod	Diameter Çap (mm)	Sack Quantity Çuval Miktarı (pcs)	Price Fiyat (USD)
503-032400	75x50	75	0,71
503-032402	110x50	75	1,17
503-032404	110x75	75	1,26
503-032406	125x110	40	2,24
503-032407	160x125	25	4,76
503-032408	160x110	10	3,99
503-032409	200x125	15	13,16
503-032410	200x110	15	13,22
503-032412	200x160	10	14,53

PVC WASTE WATER PIPE FITTINGS

PVC ATIK SU BORUSU EK PARÇALARI



SLIDING COUPLING

KAYAR MANŞON

Code Kod	Diameter Çap (mm)	Sack Quantity Çuval Miktarı (pcs)	Price Fiyat (USD)
503-032420	50	100	0,59
503-032422	75	50	0,94
503-032424	110	40	1,73
503-032426	125	30	3,52
503-032428	160	20	5,41
503-032429	200	8	10,54



S SIPHON

ES SİFON

Code Kod	Diameter Çap (mm)	Sack Quantity Çuval Miktarı (pcs)	Price Fiyat (USD)
503-032430	75x75x45	30	3,56
503-032432	75x75x87	30	3,88
503-032434	110x110x45	10	4,64
503-032436	110x110x87	10	5,47



CLEANING T

TEMİZLEME TE

Code Kod	Diameter Çap (mm)	Sack Quantity Çuval Miktarı (pcs)	Price Fiyat (USD)
702-032440	50	100	1,99
503-032441	75	50	2,87
503-032442	110	20	3,76
702-032443	125	10	7,42
503-032444	160	9	11,75
702-032446	200	4	28,97



PLUG

MUF TAPASI

Code Kod	Diameter Çap (mm)	Sack Quantity Çuval Miktarı (pcs)	Price Fiyat (USD)
503-022480	50	500	0,35
503-022482	75	200	0,63
503-022484	110	125	0,87
702-022486	125	100	2,46
702-022488	160	100	2,96
702-022490	200	35	7,48

CLAMP WITH NUT
SOMONLU KELEPÇE

Code Kod	Diameter Çap (mm)	Sack Quantity Çuval Miktarı (pcs)	Price Fiyat (USD)
702-032461	50	125	1,02
702-032463	75	60	1,88
702-032465	110	50	2,52
702-032467	125	50	2,97
702-032469	160	30	3,65



CLAMP
TRİFONLU KELEPÇE

Code Kod	Diameter Çap (mm)	Sack Quantity Çuval Miktarı (pcs)	Price Fiyat (USD)
702-032460	50	125	1,06
702-032462	75	60	1,89
702-032464	110	30	2,55
702-032466	125	25	2,96
702-032468	160	25	3,67



GASKET
CONTA

Code Kod	Diameter Çap (mm)	Sack Quantity Çuval Miktarı (pcs)	Price Fiyat (USD)
702-032480	50	-	0,16
702-032482	75	-	0,23
702-032484	110	-	0,36
702-032486	125	-	0,61
702-032488	160	-	0,88
702-032490	200	-	2,26



CLAMP WITH COVER
KAPAKLI KELEPÇE

Code Kod	Diameter Çap (mm)	Sack Quantity Çuval Miktarı (pcs)	Price Fiyat (USD)
702-022460	50	150	0,25
702-022462	75	150	0,41
702-022464	110	100	0,68
702-022466	125	100	1,23
702-022468	160	50	2,13
702-022470	200	35	4,14



U PVC ROOF DRAIN PIPE & FITTINGS

PVC ÇATI OLUĞU ve EK PARÇALARI

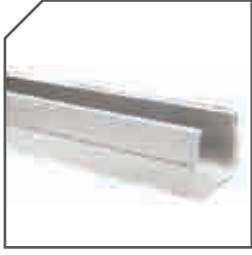

RAIN DRAIN PIPE
ÇATI OLUĞU

Code Kod	Diameter / Lenght Çap / Boy (mm)	Bundle Quantity Paket Miktarı (pcs)	Price Fiyat (USD)
702-015040	150x4000	5	20,35



RAIN DRAIN PIPE WITH CORNER 90°
OLUK DİRSEĞİ 90°

Code Kod	Diameter / Lenght Çap / Boy (mm)	Bundle Quantity Paket Miktarı (pcs)	Price Fiyat (USD)
702-015041	150	24	3,31



RAIN DRAIN PIPE SOCKET
OLUK MANŞONU

Code Kod	Diameter / Lenght Çap / Boy (mm)	Bundle Quantity Paket Miktarı (pcs)	Price Fiyat (USD)
702-015042	150	40	3,13



RAIN DRAIN PIPE OUTLET
OLUK İNİŞ

Code Kod	Diameter / Lenght Çap / Boy (mm)	Bundle Quantity Paket Miktarı (pcs)	Price Fiyat (USD)
702-015043	150x75	24	3,68
702-015045	150x110	24	6,58



RAIN DRAIN PIPE STOP END
OLUK KÖR TAPASI

Code Kod	Diameter / Lenght Çap / Boy (mm)	Bundle Quantity Paket Miktarı (pcs)	Price Fiyat (USD)
702-015044	150	150	0,79

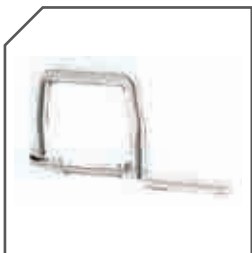

DRAINAGE CLAMP
OLUK KELEPÇESİ

Code Kod	Diameter / Lenght Çap / Boy (mm)	Bundle Quantity Paket Miktarı (pcs)	Price Fiyat (USD)
702-015046	150	75	1,07

PP WASTE WATER PIPE TYPE 2 (2.2 mm)
PP ATIK SU BORUSU TİP 2 (2.2 mm)

Code Kod	Diameter/Lenght Çap / Boy (mm)	Thickness Et Kalınlığı (mm)	Bundle / Sack Quantity Paket Miktarı (pcs)	Packing Type Ambalaj Tipi	Price/pcs Fiyat/boy (USD)
503-042000	50/150	1.8	150	Sack Çuval	0,61
503-042002	50/250	1.8	100	Sack Çuval	0,82
503-042004	50/500	1.8	50	Sack Çuval	1,27
503-042006	50/1000	1.8	10	Bundle Bağ	2,27
503-042008	50/2000	1.8	10	Bundle Bağ	4,27
503-042010	50/3000	1.8	10	Bundle Bağ	6,19
503-042012	50/6000	1.8	5	Bundle Bağ	12,34
503-042014	75/150	1.9	70	Sack Çuval	0,93
503-042016	75/250	1.9	50	Sack Çuval	1,23
503-042018	75/500	1.9	25	Sack Çuval	2,04
503-042020	75/1000	1.9	10	Bundle Bağ	3,67
503-042022	75/2000	1.9	10	Bundle Bağ	6,84
503-042024	75/3000	1.9	10	Bundle Bağ	9,99
503-042026	75/6000	1.9	5	Bundle Bağ	19,97
503-042028	110/150	2.7	35	Sack Çuval	1,59
503-042030	110/250	2.7	25	Sack Çuval	2,14
503-042032	110/500	2.7	12	Sack Çuval	3,53
503-042034	110/1000	2.7	6	Bundle Bağ	6,31
503-042036	110/2000	2.7	6	Bundle Bağ	12,75
503-042038	110/3000	2.7	6	Bundle Bağ	18,93
503-042040	110/6000	2.7	3	Bundle Bağ	25,54
503-042042	125/150	3.1	25	Sack Çuval	1,77
503-042044	125/250	3.1	15	Sack Çuval	2,76
503-042046	125/500	3.1	10	Sack Çuval	4,41
503-042048	125/1000	3.1	3	Bundle Bağ	7,72
503-042050	125/2000	3.1	3	Bundle Bağ	14,37
503-042052	125/3000	3.1	3	Bundle Bağ	21,14
503-042054	125/6000	3.1	3	Bundle Bağ	40,57
503-042056	160/150	3.9	15	Sack Çuval	3,41
503-042058	160/250	3.9	9	Sack Çuval	4,68
503-042060	160/500	3.9	5	Sack Çuval	7,92
503-042062	160/1000	3.9	3	Bundle Bağ	14,55
503-042064	160/2000	3.9	3	Bundle Bağ	27,67
503-042066	160/3000	3.9	3	Bundle Bağ	40,97
503-042068	160/6000	3.9	3	Bundle Bağ	81,62

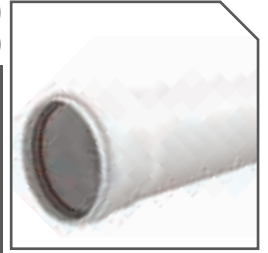

PP WASTE WATER PIPE FITTINGS

PP ATIK SU BORUSU EK PARÇALARI



45° ELBOW

DİRSEK 45°

Code Kod	Diameter Çap (mm)	Sack Quantity Çuval Miktarı (pcs)	Price Fiyat (USD)
503-022200	50x45	100	0,49
503-022202	75x45	40	0,87
503-022204	110x45	15	1,99
503-022206	125x45	10	2,93
503-022208	160x45	5	5,05



87° ELBOW

DİRSEK 87°

Code Kod	Diameter Çap (mm)	Sack Quantity Çuval Miktarı (pcs)	Price Fiyat (USD)
503-022224	50x87	100	0,56
503-022226	75x87	40	0,96
503-022228	110x87	15	2,55
503-022230	125x87	10	3,38
503-022232	160x87	5	6,27



45° SINGLE BRANCH

TEK ÇATAL 45°

Code Kod	Diameter Çap (mm)	Sack Quantity Çuval Miktarı (pcs)	Price Fiyat (USD)
503-022250	50x50x45	50	1,05
503-022252	75x50x45	25	1,44
503-022254	75x75x45	15	1,92
503-022256	110x50x45	10	2,64
503-022258	110x75x45	10	3,23
503-022260	110x110x45	6	4,29



87° T BRANCH

TE ÇATAL 87°

Code Kod	Diameter Çap (mm)	Sack Quantity Çuval Miktarı (pcs)	Price Fiyat (USD)
503-022300	50x50x87	50	1,03
503-022302	75x50x87	30	1,48
503-022304	75x75x87	20	1,93
503-022306	110x50x87	15	2,35
503-022308	110x75x87	10	3,34
503-022310	110x110x87	8	3,65

45° DOUBLE BRANCH

ÇİFT ÇATAL 45°

Code Kod	Diameter Çap (mm)	Sack Quantity Çuval Miktarı (pcs)	Price Fiyat (USD)
503-022350	50x50x45	30	2,18
503-022352	75x50x45	20	3,09
503-022354	75x75x45	10	5,54
503-022356	110x50x45	10	5,93
503-022358	110x110x45	5	6,12



87° CROSS T

İSTAVROZ TE ÇATAL 87°

Code Kod	Diameter Çap (mm)	Sack Quantity Çuval Miktarı (pcs)	Price Fiyat (USD)
503-022370	110x50x87	10	4,45
503-022372	110x110x87	6	8,53



REDUCING SOCKET

REDÜKSİYON

Code Kod	Diameter Çap (mm)	Sack Quantity Çuval Miktarı (pcs)	Price Fiyat (USD)
503-022400	75x50	75	0,84
503-022402	110x50	30	1,38
503-022404	110x75	25	1,44
503-022406	125x110	20	2,56
503-022408	160x110	10	4,35
503-022407	160x125	10	5,42



SLIDING COUPLING

KAYAR MANŞON

Code Kod	Diameter Çap (mm)	Sack Quantity Çuval Miktarı (pcs)	Price Fiyat (USD)
503-022420	50	100	0,78
503-022422	75	50	1,15
503-022424	110	20	1,96



PP WASTE WATER PIPE FITTINGS

PP ATIK SU BORUSU EK PARÇALARI



S SIPHON
ES SIFON

Code Kod	Diameter Çap (mm)	Sack Quantity Çuval Miktarı (pcs)	Price Fiyat (USD)
503-022434	110x110x45	5	6,92
503-022436	110x110x87	5	7,64



CLEANING T
TEMİZLEME TE

Code Kod	Diameter Çap (mm)	Sack Quantity Çuval Miktarı (pcs)	Price Fiyat (USD)
503-022442	110	10	5,63



PLUG
MUF TAPASI

Code Kod	Diameter Çap (mm)	Sack Quantity Çuval Miktarı (pcs)	Price Fiyat (USD)
503-022480	50	500	0,41
503-022482	75	200	0,73
503-022484	110	125	1,01

silenzio

**SILENT THREE LAYERED
WASTE WATER PIPES
SESSİZ ÜÇ KATLI BORU**

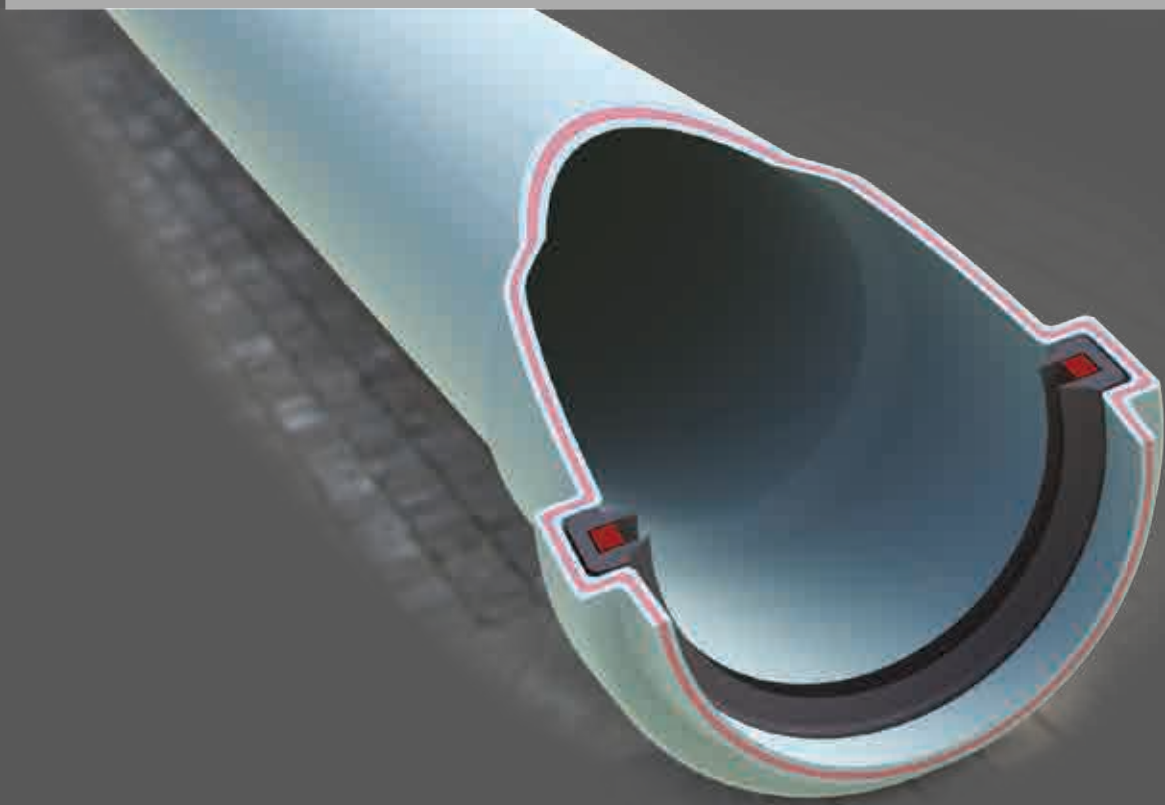

SANICA

SILENZIO - PROVIDES QUIET ENVIRONMENT

Silenzio - Sound Proof Waste Water Pipe System
Silenzio is made by mineral reinforced polypropylene high quality sound proof pipe system.
Silenzio products provide excellent sound isolation and create ideal living conditions for any type of buildings, houses, hospitals, hotels and etc.
Sound isolated pipe systems make contribution of increasing life quality and property's value.
Nowadays, taking into consideration of high housing demands, Silenzio pipe systems meet technological and economical expectations fully.
Silenzio is with special formula that contains high level molecular weight and 3 layers structure, blocks the sound out of the waste water's impact to the inner surface. At the same time, with the special structure, it decreases the vibration of the installation; thereby, all the sounds that caused by vibration in the building are prevented.

SES GEÇİRMEYEN ATIKSU BORU SİSTEMİ SILENZIO

Silenzio Mineral takviyeli polipropilenden yapılmış yüksek kaliteli ses geçirmeyen boru sistemidir. Silenzio ürünleri bina yapımının her alanında (ev. konut. endüstriyel bina ve hastaneler. otel vs.) Geleceğe yönelik kullanımlar için ideal koşullar yaratarak mükemmel bir ses yalıtımı olanağı sağlar.

Ses yalıtımlı boru sistemleri. yaşam kalitesiyle birlikte mülk değerinin artmasında katkıda bulunur. Günümüzde iskan alanlarındaki yüksek talepler göz önünde bulundurulduğunda silenzio boru sistemleri teknolojik ve ekonomik beklentileri tam anlamıyla karşılamaktadır.

Silenzio yüksek moleküler ağırlıktaki özel formülü ve 3 katlı yapısıyla atığın boru iç yüzeyine çarpmasıyla oluşan sesin tesisatın dışına çıkmasını engeller.

Aynı zamanda özel yapısı tesisat yapısı üzerindeki titreşimleri büyük oranda azaltmaktadır. Böylece bina içersinde titreşimler sonucu meydana gelen temas sesleri ve uğultular engellenmiş olur.

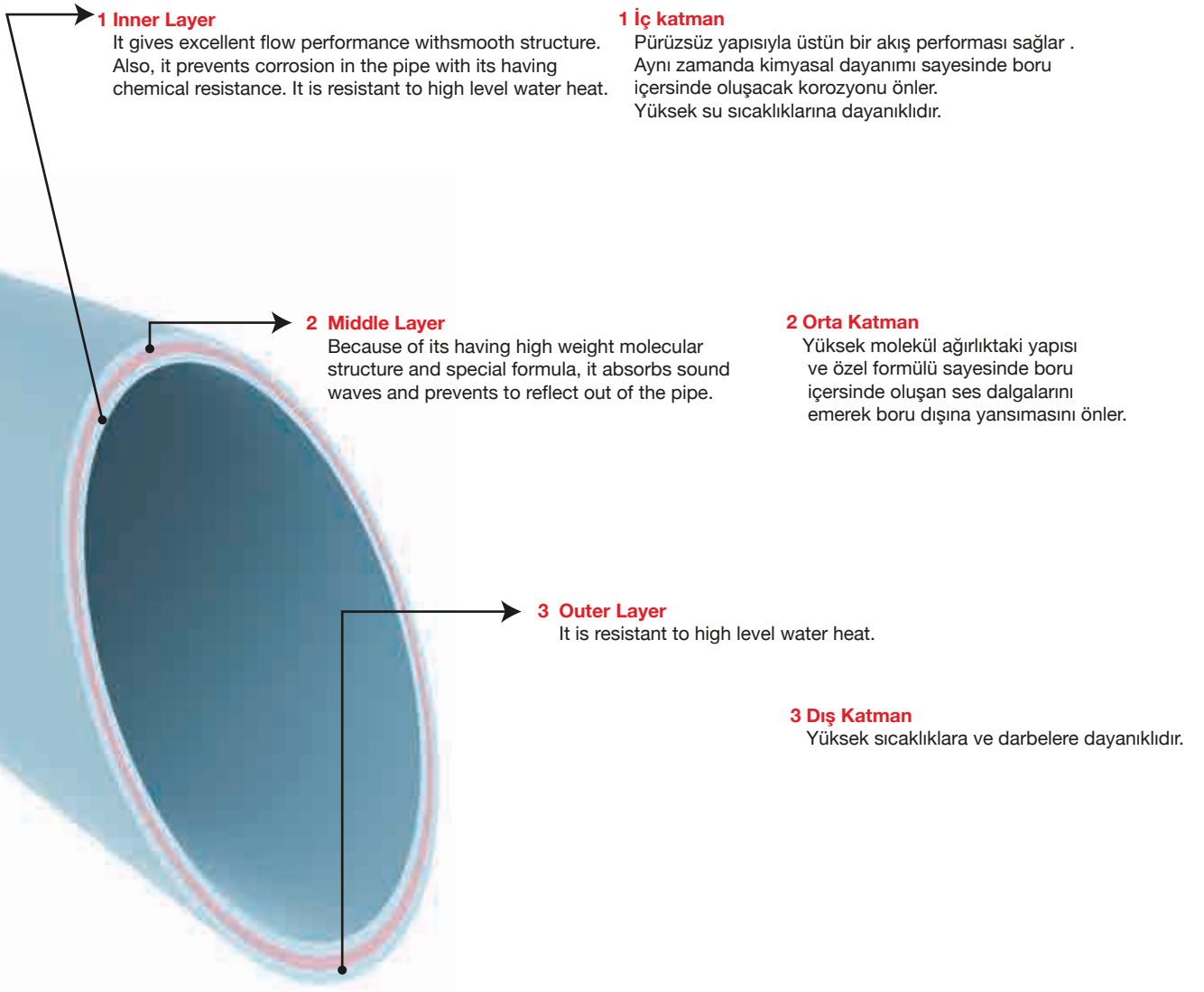

WHAT IS SOUND?

Sound is a sense from ear to the brain and a mechanical vibration in gases, liquids and solids sensed by eardrum. Any mechanical vibration creating sound has a frequency. The human ear can hear sounds with frequencies from 16 Hz (very low tone) to approximately 16.000 Hz (very high tone). Any sound with no proper frequency creates noise. Noise may also be defined as an unpleasant, undesired and disturbing sound.

HOW TO MEASURE SOUND?

To measure sound intensity, measuring instruments called sonometers are used. Sonometer indicates sound intensity in decibels (dB). (dB) is a unit of sound intensity to which the human ear is sensitive the most and where high frequencies are particularly emphasized. The sound waves with certain frequencies create a pressure moving in a gas or liquid, which is called sound pressure. The unit of measurement of sound pressure is microbar (μ b).

EFFECTS OF NOISE ON HUMANS

Acoustic pollution or noise is more common than the other types of pollution. They cause the quality of personal or social life to be transformed. When dealing with an environmental issue, first the maximum limits of noise acceptable for the human and social health (noise criteria and limits) should be demonstrated, and then the existing noise circumstances in the environment examined should be determined by measurement and estimation and therefore the studies to control noise in a system should be conducted. Noise that has highly adverse effects on the human health and comfort may lead to psychological and physiological effects such as hypertension, headache, restlessness, and nervousness. Sounds and noises created in a habitat may reduce business efficiency, disturb concentration and interrupt resting and sleeping. Continuous exposure might derange the mental and physiological health.

SOUND FORMATION IN BUILDINGS

Diameter reductions in a fresh water installation, the shift of sound direction, the highness of the water rate (wrong selection of the pipe diameter), the formation of cavitation required from shrinking points, the parts and mechanisms in the flush filling and discharging elements and the water discharged from their connections create sound (noise) in a pipe. The higher the buildings and the more the water supplies connected to the interim lines, the more exponentially the level of a sound increases.

SOUND PRESSURE LEVELS OF DIFFERENT SOUNDS

0	-	10	dB perceptible arm watch tick
15	-	20	dB quiet environment
20	-	30	dB whispering in a quiet environment
50	-	60	dB natural conversation environment
60	-	65	dB office and shopping center noise
70	-	75	dB street noise
90	-	100	dB nearby train noise
100	-	110	dB motorcycle noise without muffler
120	-	140	dB air plane take off

SES NEDİR?

Ses, kulaktan beyine bir duyu olup kulak zarı tarafından algılanan gaz, sıvı ve katı maddelerdeki mekanik titreşimdir. Sesi oluşturan mekanik titreşimler bir frekansa sahiptir. İnsan kulağı 16 Hz (çok düşük ton) ile yaklaşık 16000 Hz (çok yüksek ton) arası frekanslardaki sesleri duyabilir. Frekansı düzgün olmayan sesler gürültüyü oluşturur. Gürültü; hoş gitmeyen, istenmeyen rahatsız edici ses olarak da tanımlanabilir.

SESİ NASIL ÖLÇERSİNİZ?

Ses şiddetini ölçmek için, Sonometre denilen ölçüm aletleri kullanılır. Sonometre sesin şiddetini desibel (dB) cinsinden verir. (dB) İnsan kulağının en çok hassas olduğu ve yüksek frekansların özellikle vurgulandığı bir ses değerlendirme birimidir. Belirli frekanslara sahip ses dalgaları gaz ve sıvı içinde hareket ederken bir basınç oluşturur. Buna ses basıncı denir. Ses basıncının ölçüm birimi u bar (micro bar)'dır.

GÜRÜLTÜNÜN İNSANLAR ÜZERİNDEKİ ETKİLERİ

Akustik kirlilik ya da gürültü, diğer kirlilik türlerine göre daha yaygındır. Kişisel ve toplumsal yaşam kalitesinin dönüşmesine neden olur. Bir çevre sorunu ele alındığında, öncelikle gürültünün insan ve toplum sağlığı açısından kabul edilecek en yüksek düzeylerin (gürültü, ölçüt ve limitlerinin) ortaya konması daha sonra incelenen çevredeki mevcut gürültü koşullarının ölçüm ve tahmin yönetmeleri ile belirmesi ve bunlara bağlı olarak gürültünün bir sistem içinde kontrol altına alınması çalışmalarının yapılması gerekmektedir.

İnsan sağlığı ve konforu üzerinde çok olumsuz etkileri olan gürültü; yüksek tansiyon, baş ağrısı, huzursuzluk sinirlilik gibi psikolojik ve fizyolojik tesirlere neden olan bir olgudur. Yaşam ortamı içinde oluşan ses ve gürültüler iş verimini düşürür konsantrasyonu bozar, dinlenme ve uykuyu bölebilir. Sürekli etki halinde kalınması ruhsal ve fizyolojik sağlığı bozabilir.

BİNA İÇLERİNDE SES OLUŞUMU

Temiz su tesisatındaki çap daralmaları, suyun yön değiştirmesi su hızının yüksek olması (Boru çapının uygun seçilmemesi) daralan noktalardan gereken kavitasyon oluşumu sifonlarda boşaltma doldurma elemanlardaki parça ve mekanizmalar ve bunların bağlantılarından boşaltılan sular boru içinde sesi (gürültüyü) oluşturur. Binalar ne kadar yüksek ve ara hatlara bağlanan su kaynakları ne kadar fazla olursa sesin oranı katlamalı olarak artar.

FARKLI SESLERİN SES BASINÇ SEVİYELERİ

10 dB	Duyulabilir kol saati tıklaması.
15 - 20	dB Sessiz ortam.
20 - 30	dB Sessiz ortamda fısıldama.
50 - 60	dB Normal sohbet ortamı.
60 - 65	dB Büro, alışveriş merkezi gürültüsü.
70 - 75	dB Cadde gürültüsü.
90 - 100	dB Yakından geçen tren sesi.
100 - 110	dB Susturucusuz motorsiklet sesi.
120 - 140	dB Kalkış halindeki uçak.

INDOOR TECHNICAL INSTALLATIONS MAKING NOISE

Sanitary installations and wastewater installations, radiators, ventilation and air-conditioning systems, washing machines, common washing installations, stationary kitchens - refrigerators, non-stationary home appliances (vacuum cleaners), fittings.

GÜRÜLTÜ YAPAN EV İÇİ TEKNİK TESİSATLAR

Sıhhi tesisat ve pis su tesisatları, kalorifer, havalandırma ve klima tesisatları, çamaşır makinası - ortak yıkama tesisatları, sabit mutfaklar - buzdolapları, sabit olmayan ev aletleri - (elektrik süpürgesi) armatürler.

1) By Air

Sound waves spreading in the air create pressure in the environment and vibration in the objects and surfaces they hit.

The special high molecular weight formula used in the middle layers of the three-layer SILENZIO absorbs that pressures and prevents it from being reflected outside the pipe.

1) Hava Yolu İle

Hava yolu ile yayılan ses dalgaları ortam içerisinde basınç oluşturmakta, çarptığı cisimler ve yüzeylerde titreşim meydana getirmektedir.

Üç katlı SILENZIO orta katlarında kullanılan yüksek molekül ağırlığındaki özel formül bu basıncı absorbe edip boru dışına çıkmasını engeller.

FORMATION OF SOUND IN WASTEWATER SYSTEMS

The sound created in the water pipe by water in wastewater systems is transmitted as unstable noise to the environment in two ways.

ATIK SU SİSTEMLERİNDE SES OLUŞUMU

Atık su sistemlerinde suyun atık su borusu içerisinde oluşturduğu ses düzensiz bir gürültü olarak iki şekilde ortama iletilir.

2) With Contact

In wastewater installations, wastewater and waste hitting the pipe wall creates vibrations in the pipe system.

Those vibrations are transmitted with contact onto the wall where the installation is.

The sound created with contact is absorbed to a great extent with SILENZIO's special molecular structure.

2) Temas Yolu İle

Atık su tesisatlarında, pis su ve atığın boru giderine çarpması neticesinde boru sisteminde titreşimler meydana gelmektedir. Bu titreşimler temas yolu ile tesisatın bulunduğu duvar üzerine aktarılır.

Temas yolu ile oluşan ses SILENZIO'nun özel moleküler yapısı sayesinde büyük oranda absorbe edebilir.

PIYASADA BULUNAN DİĞER BORULARIN SES DEĞERLERİ



15 dB (A) = Atık Su Sisteminizde ulaşabileceğiniz ses değeri
SILENZIO SES GEÇİRMEYEN BORU SİSTEMİ ile insan kulağının
duyabileceği en alt seviyeye yakın akustik değerler elde edilmektedir.

DIN 4109 ve VDI DİREKTİF 4100 YÖNETMELİĞİNE GÖRE SES GEÇİRMEZLİK

DIN EN 14366 Ya göre Ses geçirmezlik ölçümleri Fraunhofer Yapıfiziği Enstitüsü		Boru Sistemi SILENZIO			
Volum akımı (1/s)		0,5	1	2	4
Tüm kelepçeler açık db (A)		3	6	11	18
Tüm kelepçeler kapalı db (A)	Karakteristik gövde ses göstergisi LSCA db (A)	3	9	12	16

Test room and plant design related to the test of noise level at authorized German technical institutes

1. DN/OD 110/87 T-piece
2. 2x45 bracket and 250mm pipe
3. Straight fixation
4. Pedestal fixation
5. Sliding fixation
6. Discharge

Back entrance and back basement
(Measuring and recording rooms)
Installation wall: 115 mm sand-lime brick
(220 kg/m³)

Water discharge: Continuously from WC
Q = 0.5 l / sec (30 l / min)
Q = 1.0 l / sec (60 l / min)
Q = 2.0 l / sec (120 l / min)
Q = 4.0 l / sec (240 l / min)

Test odası ve yetkili alman teknik enstitülerinde gürültü seviyesi test ile ilgili tesis tasarımı.

1. DN/OD 110/87 T-parça
2. 2x45 dirsek ve 250mm boru
3. Düz sabitleme
4. Ayaklı sabitleme
5. Kayar sabitleme
6. Deşarj

Arka giriş ve arka bodrum
(Ölçüm ve kayıt odaları)
Tesisat duvarı: 115mm kum-kireç tuğlası
(220 kg/m³)

Su deşarjı: WC den sürekli olarak
Q = 0.5 l / sn (30 l / dak)
Q = 1.0 l / sn (60 l / dak)
Q = 2.0 l / sn (120 l / dak)
Q = 4.0 l / sn (240 l / dak)

Fraunhofer Institut für Bauphysik

Table 1 SANICA A.S., acoustic measurements according to DIN 4109 and EN 14366 of November 10, 2011. Sound pressure levels measured in the installation test facility. Test object was the wastewater installation system "SANICA SILENZIO, 110 x 3.2" (manufacturer SANICA A.S.). The wastewater system consisted of straight plastic pipes and fittings (size OD 110 mm) and standard steel pipe clamps "xxxxx" by xxxxxx.

	Wastewater system "SANICA SILENZIO, 110 x 3.2" with pipe clamps "xxxxx"			
Flow rate [l/s]	0,5	1,0	2,0	4,0
Installation sound level L _i [dB(A)] measured in the basement test-room (DG front *)	48,2	52,0	53,8	55,8
Installation sound level L _i [dB(A)] measured in the basement test-room (UG rear †)	17,7	22,4	24,3	28,3
Airborne sound pressure level L _p [dB(A)]	48,2	52,0	53,8	55,8
Structure-borne sound characteristic level L _w [dB(A)] †	16,1	20,9	22,8	25,6

* Evaluation according to DIN 4109
† Evaluation according to EN 14366

Table 1a as with table 1, but with rounded values

	Wastewater system "SANICA SILENZIO, 110 x 3.2" with pipe clamps "xxxxx"			
Flow rate [l/s]	0,5	1,0	2,0	4,0
Installation sound level L _i [dB(A)] measured in the basement test-room (DG front *)	48	52	54	56
Installation sound level L _i [dB(A)] measured in the basement test-room (UG rear †)	18	22	24	28
Airborne sound pressure level L _p [dB(A)]	48	52	54	56
Structure-borne sound characteristic level L _w [dB(A)] †	16	21	23	27

* Evaluation according to DIN 4109
† Evaluation according to EN 14366

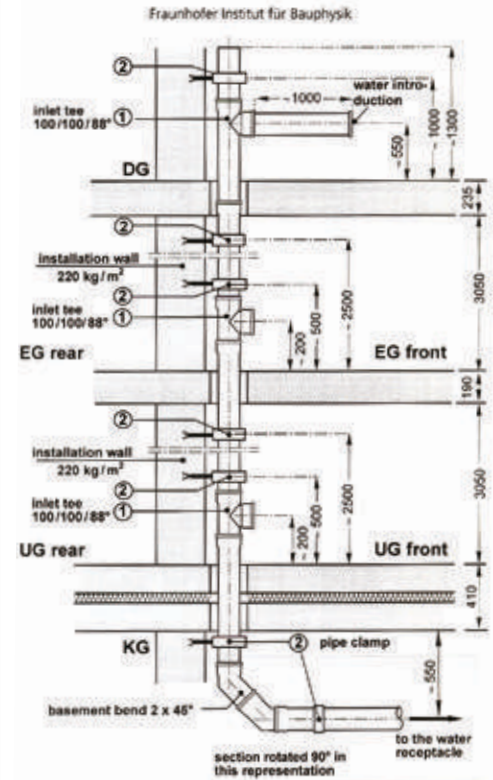

SILENT THREE LAYERED WASTE WATER PIPES

SESSİZ ÜÇ KATLI ATIK SU BORUSU

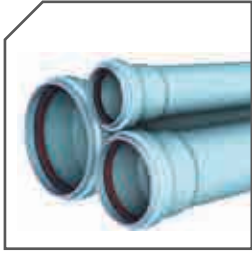

SILENZIO WASTE WATER PIPES

SESSİZ ATIK SU BORUSU

Code Kod	Diameter/Lenght Çap / Boy (mm)	Thickness Et Kalınlığı (mm)	Bundle / Sack Quantity Paket Miktarı (pcs)	Packing Type Ambalaj Tipi	Price/pcs Fiyat/boy (USD)
503-052000	50/150	2.2	150	Çuval Sack	0,87
503-052002	50/250	2.2	100	Çuval Sack	1,17
503-052004	50/500	2.2	50	Çuval Sack	1,71
503-052006	50/1000	2.2	10	Bağ Bundle	2,93
503-052008	50/2000	2.2	10	Bağ Bundle	5,55
503-052010	50/3000	2.2	10	Bağ Bundle	8,33
503-052012	50/6000	2.2	5	Bağ Bundle	16,46
503-052014	75/150	2.4	70	Çuval Sack	1,35
503-052016	75/250	2.4	50	Çuval Sack	1,87
503-052018	75/500	2.4	25	Çuval Sack	3,06
503-052020	75/1000	2.4	10	Bağ Bundle	5,02
503-052022	75/2000	2.4	10	Bağ Bundle	9,79
503-052024	75/3000	2.4	10	Bağ Bundle	13,72
503-052026	75/6000	2.4	3	Bağ Bundle	25,54
503-052028	110/150	3.2	35	Çuval Sack	2,47
503-052030	110/250	3.2	25	Çuval Sack	3,39
503-052032	110/500	3.2	12	Çuval Sack	5,38
503-052034	110/1000	3.2	6	Bağ Bundle	9,41
503-052036	110/2000	3.2	6	Bağ Bundle	17,98
503-052038	110/3000	3.2	6	Bağ Bundle	26,54
503-052040	110/6000	3.2	3	Bağ Bundle	51,62
503-052042	125/150	3.2	25	Çuval Sack	2,82
503-052044	125/250	3.2	15	Çuval Sack	4,14
503-052046	125/500	3.2	10	Çuval Sack	6,21
503-052048	125/1000	3.2	3	Bağ Bundle	11,19
503-052050	125/2000	3.2	3	Bağ Bundle	21,57
503-052052	125/3000	3.2	3	Bağ Bundle	31,52
503-052054	125/6000	3.2	3	Bağ Bundle	48,57
503-052056	160/150	4.0	15	Çuval Sack	4,56
503-052058	160/250	4.0	9	Çuval Sack	6,19
503-052060	160/500	4.0	5	Çuval Sack	10,84
503-052062	160/1000	4.0	3	Bağ Bundle	17,98
503-052064	160/2000	4.0	3	Bağ Bundle	33,41
503-052066	160/3000	4.0	3	Bağ Bundle	48,84
503-052068	160/6000	4.0	3	Bağ Bundle	96,17

SILENT THREE LAYERED WASTE WATER FITTINGS

SESSİZ ÜÇ KATLI ATIK SU BORUSU EK PARÇALARI

SILENZIO 45° ELBOW

SİLENZIO DİRSEK 45°

Code Kod	Diameter Çap (mm)	Sack Quantity Çuval Miktarı (pcs)	Price Fiyat (USD)
503-062200	50x45	100	0,55
503-062202	75x45	40	0,98
503-062204	110x45	15	2,27
503-062206	125x45	10	3,13
503-062208	160x45	5	5,74



SILENZIO 87° ELBOW

SİLENZIO DİRSEK 87°

Code Kod	Diameter Çap (mm)	Sack Quantity Çuval Miktarı (pcs)	Price Fiyat (USD)
503-062224	50x87	100	0,63
503-062226	75x87	40	1,09
503-062228	110x87	15	2,77
503-062230	125x87	10	3,81
503-062232	160x87	5	7,05

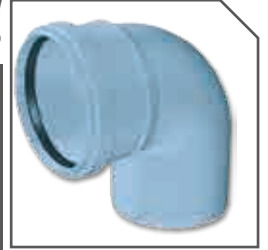

SILENZIO 45° SINGLE BRANCH

SİLENZIO TEK ÇATAL 45°

Code Kod	Diameter Çap (mm)	Sack Quantity Çuval Miktarı (pcs)	Price Fiyat (USD)
503-062250	50x50x45	50	1,09
503-062252	75x50x45	25	1,59
503-062254	75x75x45	15	2,14
503-062256	110x50x45	10	2,91
503-062258	110x75x45	10	3,57
503-062260	110x110x45	6	4,81



SILENZIO T BRANCH 87°

SİLENZIO TE ÇATAL 87°

Code Kod	Diameter Çap (mm)	Sack Quantity Çuval Miktarı (pcs)	Price Fiyat (USD)
503-062300	50x50x87	50	1,14
503-062302	75x50x87	30	1,89
503-062304	75x75x87	20	2,13
503-062306	110x50x87	15	2,64
503-062308	110x75x87	10	3,71
503-062310	110x110x87	8	4,19



SILENT THREE LAYERED WASTE WATER PIPES

SESSİZ ÜÇ KATLI ATIK SU BORUSU



SILENZIO 45° DOUBLE BRANCH

SİLENZİO ÇİFT ÇATAL 45°

Code Kod	Diameter Çap (mm)	Sack Quantity Çuval Miktarı (pcs)	Price Fiyat (USD)
503-062350	50x50x45	30	2,45
503-062352	75x50x45	20	2,85
503-062354	75x75x45	10	5,03
503-062356	110x50x45	10	6,24
503-062358	110x110x45	5	6,91



SILENZIO 87° CROSS T

SİLENZİO İSTAVROZ TE ÇATAL 87°

Code Kod	Diameter Çap (mm)	Sack Quantity Çuval Miktarı (pcs)	Price Fiyat (USD)
503-062370	110x50x87	10	4,28
503-062372	110x110x87	6	7,59



SILENZIO REDUCING SOCKET

SİLENZİO REDÜKSİYON

Code Kod	Diameter Çap (mm)	Sack Quantity Çuval Miktarı (pcs)	Price Fiyat (USD)
503-062400	75x50	75	0,95
503-062402	110x50	30	1,54
503-062404	110x75	25	1,63
503-062406	125x110	20	2,76
503-062408	160x110	10	4,18
503-062407	160x125	10	5,09



SILENZIO SLIDING COUPLING

SİLENZİO KAYAR MANŞON

Code Kod	Diameter Çap (mm)	Sack Quantity Çuval Miktarı (pcs)	Price Fiyat (USD)
503-062420	50	100	0,87
503-062422	75	50	1,27
503-062424	110	20	2,22

SILENT THREE LAYERED WASTE WATER FITTINGS

SESSİZ ÜÇ KATLI ATIK SU BORUSU EK PARÇALARI

SILENZIO S SIPHON

SİLENZİO S SIFON

Code Kod	Diameter Çap (mm)	Sack Quantity Çuval Miktarı (pcs)	Price Fiyat (USD)
503-062434	110x110x45	5	10,97
503-062436	110x110x87	5	11,73

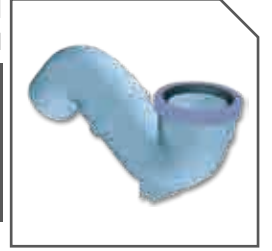

SILENZIO CLEANING T

SİLENZİO TEMİZLEME TE

Code Kod	Diameter Çap (mm)	Sack Quantity Çuval Miktarı (pcs)	Price Fiyat (USD)
503-062442	110	10	5,52



SILENZIO PLUG

SİLENZİO MUF TAPASI

Code Kod	Diameter Çap (mm)	Sack Quantity Çuval Miktarı (pcs)	Price Fiyat (USD)
503-062480	50	500	0,47
503-062482	75	200	0,84
503-062484	110	75	1,16



SUPER SILENT SÜPER SESSİZ

SUPER SILENT THREE LAYERED
WASTE WATER PIPES
SÜPER SESSİZ ÜÇ KATLI BORU

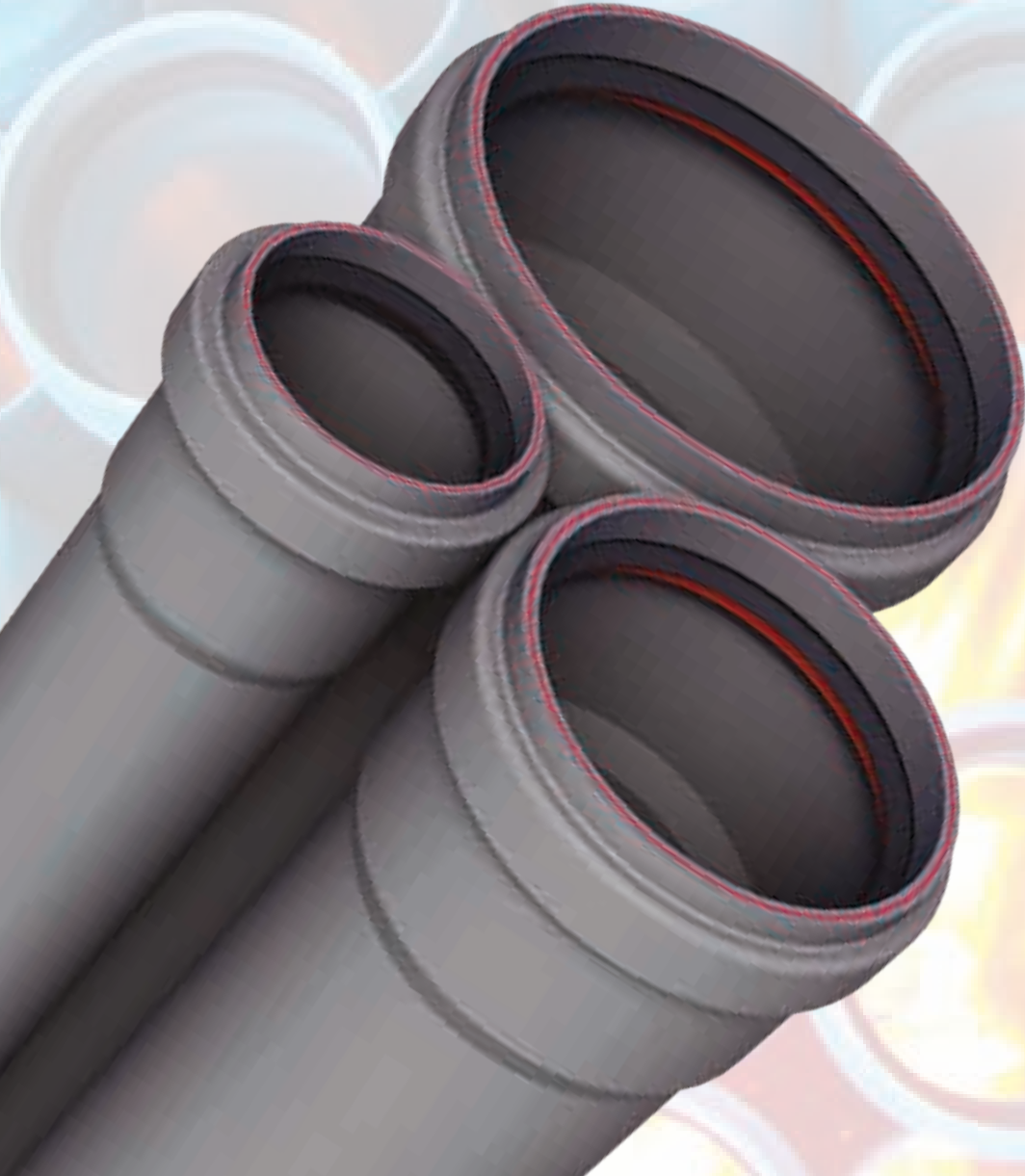

SUPER SILENT PIPE
SÜPER SESSİZ BORU



Kod Code	Çap Diameter (mm)	Paket Miktarı Bundle Quantity (pcs)	Price/pcs Fiyat/boy (USD)
503-072000	50/150	-	5,98
503-072002	50/250	-	7,75
503-072004	50/500	-	10,29
503-072006	50/1000	-	17,69
503-072008	50/2000	-	32,56
503-072010	50/3000	-	45,35
503-072014	75/150	-	6,878
503-072016	75/250	-	8,28
503-072018	75/500	-	11,14
503-072020	75/1000	-	18,82
503-072022	75/2000	-	33,66
503-072024	75/3000	-	48,5
503-072028	110/150	-	10,25
503-072030	110/250	-	11,97
503-072032	110/500	-	17,85
503-072034	110/1000	-	29,45
503-072036	110/2000	-	53,06
503-072038	110/3000	-	77,39
503-072042	125/150	-	15,76
503-072044	125/250	-	20,43
503-072046	125/500	-	29,12
503-072048	125/1000	-	38,36
503-072050	125/2000	-	69,29
503-072052	125/3000	-	94,69
503-072056	160/150	-	20,46
503-072058	160/250	-	23,29
503-072060	160/500	-	28,99
503-072062	160/1000	-	44,34
503-072064	160/2000	-	79,06
503-072066	160/3000	-	117,43
503-072074	200/500	-	52,19
503-072076	200/1000	-	105,81
503-072078	200/2000	-	208,7
503-072080	200/3000	-	310,93

SUPER SILENT PIPE FITTINGS SÜPER SESSİZ BORU EK PARÇALARI



87,5° T SINGLE BRANCH
TE TEK ÇATAL 87,5°

Code Kod	Diameter/Lenght Çap / Boy (mm)	Bundle / Sack Quantity Paket Miktarı (pcs)	Price Fiyat (USD)
503-082300	50x50 mm	-	9,04
503-082304	75x75 mm	-	14,51
503-082310	110x110 mm	-	33,68
503-082312	125x125 mm	-	55,90



SUPER SILENT REDUCING SOCKET
SÜPER SESSİZ REDÜKSİYON

Code Kod	Diameter/Lenght Çap / Boy (mm)	Bundle / Sack Quantity Paket Miktarı (pcs)	Price Fiyat (USD)
503-082400	75x50 mm	-	6,93
503-082402	110x50 mm	-	11,52
503-082404	110x75 mm	-	13,07
503-082406	125x110 mm	-	14,71
503-082407	160x125 mm	-	28,88
503-082412	160x200 mm	-	44,33



SUPER SILENT SLIDING COUPLING
SÜPER SESSİZ KAYAR MANŞON

Code Kod	Diameter/Lenght Çap / Boy (mm)	Bundle / Sack Quantity Paket Miktarı (pcs)	Price Fiyat (USD)
503-082430	200 mm	-	128,13



SUPER SILENT CLEANING T
TEMİZLEME TE

Code Kod	Diameter/Lenght Çap / Boy (mm)	Bundle / Sack Quantity Paket Miktarı (pcs)	Price Fiyat (USD)
503-082440	75x87,5° mm	-	53,69
503-082442	110x87,5° mm	-	75,71
503-082444	125x87,5° mm	-	128,41



SUPER SILENT 45° ELBOW
SÜPER SESSİZ DİRSEK 45°

Code Kod	Diameter/Lenght Çap / Boy (mm)	Bundle / Sack Quantity Paket Miktarı (pcs)	Price Fiyat (USD)
503-082200	50x45 mm	-	4,95
503-082202	75x45 mm	-	6,99
503-082204	110x45 mm	-	13,97
503-082206	125x45 mm	-	20,76
503-082208	160x45 mm	-	38,73
503-082210	200x45 mm	-	82,61

SUPER SILENT 87,5° ELBOW
SÜPER SESSİZ DİRSEK 87,5°

Code Kod	Diameter/Lenght Çap / Boy (mm)	Bundle / Sack Quantity Paket Miktarı (pcs)	Price Fiyat (USD)
503-082224	50x87,5° mm	-	5,43
503-082226	75x87,5° mm	-	8,60
503-082228	110x87,5° mm	-	16,35
503-082230	125x87,5° mm	-	27,25
503-082232	160x87,5° mm	-	46,41
503-082234	200x87,5° mm	-	103,98



SUPER SILENT 45° SINGLE BRANCH
SÜPER SESSİZ TEK ÇATAL 45°

Code Kod	Diameter/Lenght Çap / Boy (mm)	Bundle / Sack Quantity Paket Miktarı (pcs)	Price Fiyat (USD)
503-082250	50x50 mm	-	10,24
503-082252	75x50 mm	-	13,57
503-082254	75x75 mm	-	16,53
503-082256	110x50 mm	-	20,43
503-082258	110x75 mm	-	25,12
503-082260	110x110 mm	-	39,84
503-082262	125x75 mm	-	38,24
503-082264	125x110 mm	-	40,95
503-082268	125x125 mm	-	68,31
503-082272	160x110 mm	-	72,21
503-082278	200x110 mm	-	140,16
503-082282	200x160 mm	-	178,69
503-082284	200x200 mm	-	188,73



SUPER SILENT CLAMP WITH NUT
SÜPER SESSİZ SOMUNLU KELEPÇE

Code Kod	Diameter/Lenght Çap / Boy (mm)	Bundle / Sack Quantity Paket Miktarı (pcs)	Price Fiyat (USD)
702-082461	50 mm	-	2,08
702-082463	75 mm	-	3,95
702-082465	110 mm	-	5,20
702-082467	125 mm	-	6,73
702-082469	160 mm	-	7,25



SUPER SILENT CLAMP
SÜPER SESSİZ TRİFONLU KELEPÇE

Code Kod	Diameter/Lenght Çap / Boy (mm)	Bundle / Sack Quantity Paket Miktarı (pcs)	Price Fiyat (USD)
702-082460	50 mm	-	2,08
702-082462	75 mm	-	3,95
702-082464	110 mm	-	5,20
702-082466	125 mm	-	6,73
702-082468	160 mm	-	7,25



SUPER SILENT PLUG
SÜPER SESSİZ MUF TAPASI

Code Kod	Diameter Çap (mm)	Bundle / Sack Quantity Paket Miktarı (pcs)	Price Fiyat (USD)
503-062481	50	500	4,58
503-062486	75	200	5,56
503-062487	110	75	11,20



SANICA

Pipe Boru

(PE) INFRASTRUCTURE SYSTEMS
ALTYAPI SİSTEMLERİ (PE)





Total area
Toplam alan
178.000 m²

Covered area
Kapalı alan
45.000 m²

Elazığ / TURKEY

Our factory in Elazığ, a city in the South East of Turkey, established in 2011 in order to overcome the shortage of infrastructure pipe production in this region, also to allow employments to the population there. This factory is the largest and most modern plant in the region which has 178.000 m² of open space and 45.000 m² covered area.

The strategical location which allow export to neighboring countries provide a significant added value to our country.

This factory has five main items related to pipe production in our group.

- PE 100, PE 80, PE 63 PE 32 Clean Water Pipes, PE 80 Natural Gas Pipes.
- Corrugated pipe and Fittings (SN-4 , SN-8)
- PVC Clean Water Pipes.
- PVC Sewage Water Pipe and Fittings.
- Drainage Pipe with Filter and without Filter.

Elazığ fabrikamız ülkemizin özellikle doğu bölgelerindeki alt yapı konusundaki eksiklerin giderilmesi ve bölgede istihdam sağlanması için 2011 yılında üretime başlamıştır. 178.000 m² açık alanı 45.000 m² kapalı alanı bölgedeki en büyük ve en modern boru tesisidir. Stratejik bir konumda olması nedeni ile komşu ülkelere ihracat yapma açısından ülkemize ciddi oranda katma değer sağlamaktadır.

Elazığ Fabrikamızda üretimini yaptığımız ürün grubumuz beş ana kalemden oluşmaktadır.

- PE 100, PE 80, PE 63 PE 32 Temiz Su Boruları, PE 80 Doğalgaz Boruları.
- Koruge Borular ve Ek Parçaları (SN-4,SN-8)
- PVC Temiz Su Boruları.
- PVC Atık Su Boru ve Ek Parçaları
- Filtreli ve Filtresiz Drenaj Boruları

PE 100 RC POTABLE WATER PIPES
PE 100 RC TEMİZ SU BORULARI

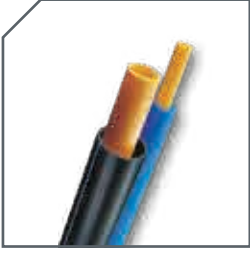

PE 100 PN-10 (SDR 17)

Diameter Çap (mm)	Thickness Kalınlık (m)	Weight Ağırlık (kg)
20	2.0	0,11
25	2.0	0,15
32	2.0	0,19
40	2.4	0,30
50	3.0	0,45
63	3.8	0,72
75	4.5	1,02
90	5.4	1,46
110	6.6	2,17
125	7.4	2,76
140	8.3	3,46
160	9.5	4,52
180	10.7	5,71
200	11.9	7,05
225	13.4	8,93
250	14.8	11,00
280	16.6	13,70
315	18.7	17,40
355	21.1	22,10
400	23.7	28,00
450	26.7	35,40
500	29.7	43,80
560	33.2	54,80
630	37.4	69,40
710	42.1	88,00
800	47.4	112,00
900	53.3	141,00
1000	59.3	175,00
1200	70.6	247,06

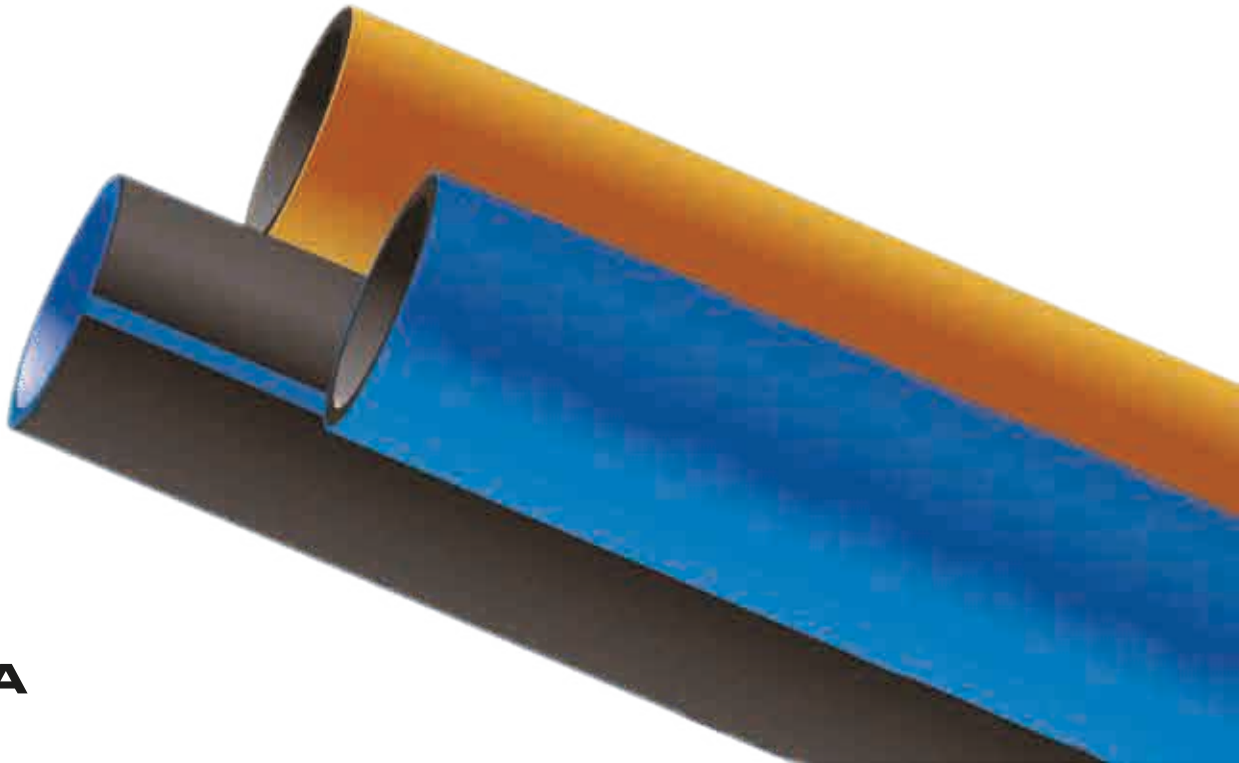

PE 100 RC PIPES
PE 100 RC BORULARI

PE 100 PN-16 (SDR 11)

Diameter Çap (mm)	Thickness Kalınlık (m)	Weight Ağırlık (kg)
20	2.0	0.11
25	2.3	0.17
32	3.0	0.27
40	3.7	0.43
50	4.6	0.67
63	5.8	1.05
75	6.8	1.47
90	8.2	2.12
110	10.0	3.14
125	11.4	4.08
140	12.7	5.08
160	14.6	6.67
180	16.4	8.42
200	18.2	10.40
225	20.5	13.10
250	22.7	16.20
280	25.4	20.30
315	28.6	25.60
355	32.2	32.50
400	36.3	41.30
450	40.9	52.30
500	45.4	64.50
560	50.8	80.80
630	57.2	102.00
710	64.5	130.00
800	72.7	163.86

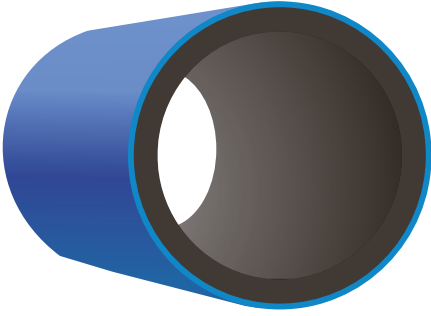
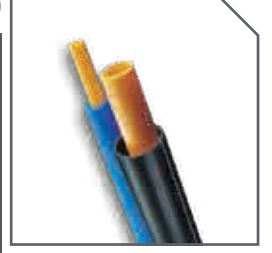

PE 100 RC PIPE

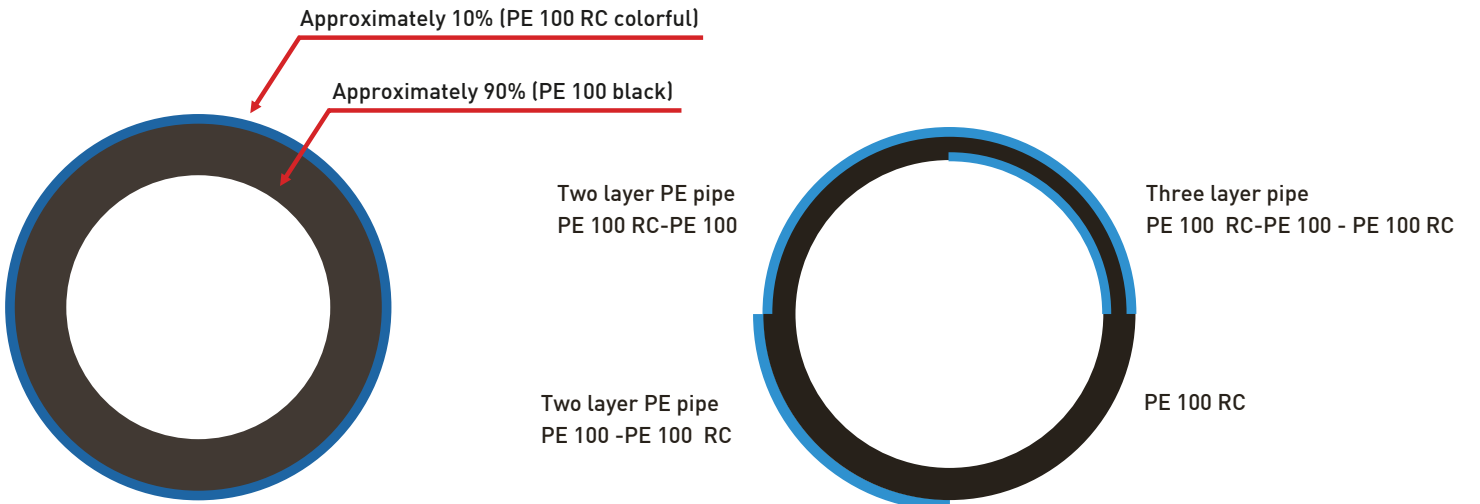

HDPE 100 BORULARI (TS 418-2 EN 12201-2, ISO 4427-2)

S _{r24} =5;S _{f50} =2,7 SDR 41;PN 4		S _{r24} =9,7;S _{f50} =5,2 SDR 33,5;PN 5		S _{r24} =17;S _{f50} =9,2 SDR 26;PN 6		S _{r24} =40;S _{f50} =21,7 SDR 21;PN 8		S _{r24} =78;S _{f50} =22,3 SDR 13,6;PN 12,5		S _{r24} =92;S _{f50} =22,3 SDR 17;PN 10		S _{r24} =110;S _{f50} =22,3 SDR 13,6;PN 12,5		S _{r24} =173;S _{f50} =33,9 SDR 11;PN 16		S _{r24} =625;S _{f50} =33,9 SDR 9;PN 20		S _{r24} =1221;S _{f50} =661 SDR 7,4;PN 25		S _{r24} =2560;S _{f50} =138 SDR 6;PN 32																																																																																																																																																																																																																																																																																																																																																																																																																																																																																																																																																																																																																																																																																																																																																																																																																																																																																																																																																																																																																																																																																																																																																				
DN	S	KG/M	DN	S	KG/M	DN	S	KG/M	DN	S	KG/M	DN	S	KG/M	DN	S	KG/M	DN	S	KG/M	DN	S	KG/M																																																																																																																																																																																																																																																																																																																																																																																																																																																																																																																																																																																																																																																																																																																																																																																																																																																																																																																																																																																																																																																																																																																																																	
75	1,80	0,46	75	2,30	0,55	75	2,90	0,67	75	3,60	0,81	75	4,50	1,02	75	5,60	1,24	75	6,80	1,47	75	8,40	1,76	75	10,30	2,09	75	12,50	2,44	75	15,20	2,88	75	18,30	3,51	75	21,80	4,24	75	25,70	5,04	75	30,00	5,94	75	34,70	6,96	75	39,80	8,10	75	45,30	9,42	75	51,20	10,92	75	57,50	12,57	75	64,20	14,37	75	71,30	16,32	75	78,80	18,42	75	86,70	20,58	75	94,90	22,95	75	103,40	25,56	75	112,20	28,35	75	121,30	31,36	75	130,70	34,59	75	140,40	38,06	75	150,40	41,78	75	160,70	45,78	75	171,30	50,61	75	182,20	55,28	75	193,40	60,61	75	204,90	65,84	75	216,70	71,22	75	228,80	76,95	75	241,20	82,74	75	253,90	89,57	75	266,90	96,42	75	280,20	103,34	75	293,80	110,42	75	307,70	117,66	75	321,90	125,00	75	336,20	132,90	75	350,70	140,92	75	365,40	149,02	75	380,30	157,31	75	395,40	165,89	75	410,70	175,00	75	426,30	184,56	75	442,10	194,12	75	458,10	203,69	75	474,30	214,17	75	490,70	224,70	75	507,30	235,19	75	524,10	246,12	75	541,10	257,06	75	558,30	267,90	75	575,70	279,60	75	593,30	292,17	75	611,10	304,92	75	629,10	318,15	75	647,10	331,98	75	665,30	349,95	75	683,70	368,88	75	702,30	387,78	75	721,10	406,62	75	740,10	426,30	75	759,10	445,62	75	778,30	464,98	75	797,70	484,50	75	817,30	503,81	75	837,10	523,49	75	857,10	543,04	75	877,30	562,86	75	897,70	583,46	75	918,30	604,05	75	939,10	625,02	75	960,10	646,86	75	981,30	669,93	75	1002,70	691,98	75	1024,50	718,41	75	1046,50	741,12	75	1068,70	769,95	75	1091,10	791,98	75	1113,70	819,12	75	1136,50	840,62	75	1159,50	861,45	75	1182,50	884,48	75	1205,70	907,81	75	1229,10	931,72	75	1251,70	956,91	75	1274,50	977,70	75	1299,70	1000,00	75	1325,10	1025,00	75	1351,30	1050,00	75	1378,10	1075,00	75	1405,50	1100,00	75	1433,10	1130,00	75	1461,10	1160,00	75	1489,50	1190,00	75	1518,30	1220,00	75	1546,50	1250,00	75	1575,10	1280,00	75	1603,30	1310,00	75	1631,10	1340,00	75	1659,10	1370,00	75	1687,30	1400,00	75	1715,70	1430,00	75	1743,10	1460,00	75	1770,50	1490,00	75	1800,00	1520,00	75	1829,50	1550,00	75	1859,10	1580,00	75	1889,30	1610,00	75	1919,10	1640,00	75	1949,10	1670,00	75	1979,30	1700,00	75	2009,70	1730,00	75	2040,50	1760,00	75	2071,50	1790,00	75	2102,70	1820,00	75	2134,10	1850,00	75	2165,70	1880,00	75	2197,50	1910,00	75	2229,50	1940,00	75	2263,70	1970,00	75	2298,10	2000,00	75	2332,30	2030,00	75	2367,10	2060,00	75	2402,10	2090,00	75	2437,10	2120,00	75	2472,30	2150,00	75	2507,70	2180,00	75	2543,30	2210,00	75	2579,10	2240,00	75	2615,10	2270,00	75	2651,30	2300,00	75	2687,70	2330,00	75	2724,30	2360,00	75	2767,10	2390,00	75	2810,10	2420,00	75	2856,10	2450,00	75	2901,30	2480,00	75	2947,70	2510,00	75	2994,30	2540,00	75	3047,10	2570,00	75	3099,10	2600,00	75	3154,30	2630,00	75	3212,70	2660,00	75	3272,70	2690,00	75	3333,10	2720,00	75	3394,30	2750,00	75	3457,30	2780,00	75	3522,70	2810,00	75	3593,30	2840,00	75	3666,10	2870,00	75	3740,10	2900,00	75	3819,30	2930,00	75	3900,00	2960,00	75	3981,50	2990,00	75	4065,10	3020,00	75	4151,30	3050,00	75	4243,30	3080,00	75	4337,70	3110,00	75	4432,70	3140,00	75	4525,10	3170,00	75	4620,10	3200,00	75	4710,10	3230,00	75	4800,00	3260,00	75	4893,30	3290,00	75	4989,10	3320,00	75	5091,30	3350,00	75	5193,70	3380,00	75	5299,70	3410,00	75	5410,10	3440,00	75	5525,30	3470,00	75	5651,10	3500,00	75	5787,10	3530,00	75	5929,10	3560,00	75	6073,30	3590,00	75	6217,70	3620,00	75	6311,10	3650,00	75	6403,30	3680,00	75	6497,70	3710,00	75	6593,10	3740,00	75	6695,30	3770,00	75	6797,70	3800,00	75	6900,00	3830,00	75	7007,30	3860,00	75	7115,10	3890,00	75	7230,10	3920,00	75	7351,30	3950,00	75	7475,70	3980,00	75	7615,10	4010,00	75	7767,30	4040,00	75	7917,70	4070,00	75	8075,10	4100,00	75	8237,30	4130,00	75	8403,70	4160,00	75	8577,10	4190,00	75	8757,30	4220,00	75	8937,70	4250,00	75	9129,10	4280,00	75	9323,30	4310,00	75	9515,10	4340,00	75	9703,30	4370,00	75	9893,70	4400,00	75	10083,10	4430,00	75	10275,30	4460,00	75	10469,70	4490,00	75	10663,10	4520,00	75	10853,30	4550,00	75	11049,70	4580,00	75	11237,70	4610,00	75	11429,10	4640,00	75	11613,30	4670,00	75	11799,70	4700,00	75	11977,70	4730,00	75	12159,10	4760,00	75	12341,30	4790,00	75	12505,70	4820,00	75	12683,10	4850,00	75	12821,30	4880,00	75	12971,70	4910,00	75	13103,10	4940,00	75	13279,70	4970,00	75	13453,10	5000,00	75	13605,30	5030,00	75	13767,70	5060,00	75	13915,10	5090,00	75	14073,30	5120,00	75	14219,70	5150,00	75	14381,10	5180,00	75	14503,30	5210,00	75	14659,70	5240,00	75	14803,10	5270,00	75	14967,70	5300,00	75	15119,10	5330,00	75	15283,30	5360,00	75	15453,70	5390,00	75	15617,10	5420,00	75	15789,70	5450,00	75	15967,70	5480,00	75	16157,10	5510,00	75	16333,30	5540,00	75	16507,70	5570,00	75	16681,10	5600,00	75	16843,30	5630,00	75	17003,70	5660,00	75	17167,10	5690,00	75	17335,30	5720,00	75	17503,70	5750,00	75	17677,10	5780,00	75	17853,30	5810,00	75	18033,70	5840,00	75	18213,10	5870,00	75	18387,30	5900,00	75	18565,70	5930,00	75	18747,10	5960,00	75	18913,30	5990,00	75	19087,70	6020,00	75	19261,10	6050,00	75	19437,30	6080,00	75	19603,70	6110,00	75	19783,10	6140,00	75	19937,30	6170,00	75	20093,70	6200,00	75	20253,10	6230,00	75	20417,30	6260,00	75	20583,70	6290,00	75	20713,10	6320,00	75	20887,30	6350,00	75	21053,70	6380,00	75	21233,10	6410,00	75	21403,30	6440,00	75	21557,70	6470,00	75	21717,10	6500,00	75	21883,30	6530,00	75	22043,70	6560,00	75	22213,10	6590,00	75	22387,30	6620,00	75	22563,70	6650,00	75	22743,10	6680,00	75	22913,30	6710,00	75	23077,70	6740,00	75	23233,10	6770,00	75	23393,30	6800,00	75	23553,70	6830,00	75	23713,10	6860,00	75	23877,30	6890,00	75	24043,70	6920,00	75	24213,10	6950,00	75	24387,30	6980,00	75	24553,70	7010,00	75	24723,10	7040,00	75	24893,30	7070,00	75	25063,70	7100,00	75	25233,10	7130,00	75	25403,30	7160,00	75	25577,70	7190,00	75	25753,10	7220,00	75	25923,30	7250,00	75	26093,70	7280,00	75	26263,10	7310,00	75	26433,30	7340,00	75	26603,70	7370,00	75	26773,10	7400,00	75	26943,30	7430,00	75	27113,70	7460,00	75	27283,10	7490,00	75	27453,30	7520,00	75	27623,70	7550,00	75	27793,10	7580,00	75	27963,30	7610,00	75	28133,70	7640,00	75	28303,10	7670,00	75	28473,30	7700,00	75	28643,70	7730,00	75	28813,10	7760,00	75	28983,30	7790,00	75	29153,70	7820,00	75	29323,10	7850,00	75	29493,30	7880,00	75	29663,70	7910,00	75	29833,10	7940,00	75	30003,30	7970,00	75	30173,70	8000,00	75	30343,10	8030,00	75	30513,30	8060,00	75	30683,70	8090,00	75	30853,10	8120,00	75	31023,30	8150,00	75	31193,70	8180,00	75	31363,10	8210,00	75	31533,30	8240,00	75	31703,70	8270,00	75	31873,10	8300,00	75	32043,30	8330,00	75	32213,70	8360,00	75	32383,10	8390,00	75	32553,30	8420,00	75	32723,70	8450,00	75	32893,10	8480,00	75	33063,30	8510,00	75	33233,70	8540,00	75	33403,10	8570,00	75	33573,30	8600,00	75	33743,70	8630,00	75	33913,10	8660,00	75	34083,30	8690,00	75	34253,70	8720,00	75	34423,10	8750,00	75	34593,30	8780,00	75	34763,70	8810,00	75	34933,10	8840,00	75	35103,30	8870,00	75	35273,70	8900,00	75	35443,10	8930,00	75	35613,30	8960,00	75	35783,70	8990,00	75	35953,10	9020,00	75	36123,30	9050,00	75	36293,70	9080,00	75	36463,10	9110,00	75	36633,30	9140,00	75	36803,70	9170,00	75	36973,10	9200,00	75	37143,30	9230,00	75	37313,70	9260,00	75	37483,10	9290,00	75	37653,30	9320,00	75	37823,70	9350,00	75	38003,10	9380,00	75

PE 32 POTABLE WATER PIPES
PE 32 TEMİZ SU BORULARI

PE 32 PN-6 Atm

Code Kod	Diameter Çap (mm)	Coil Length Paket Miktarı (m)	Price Fiyat (USD)/m
502-1063220	20	100 m kangal	0,83
502-1063225	25	100 m kangal	1,20
502-1063232	32	100 m kangal	1,95
502-1064040	40	100 m kangal	3,00
502-1065050	50	100 m kangal	4,65
502-1066363	63	100 m kangal	7,20
502-1006757	75	100 m kangal	10,00



PE 32 PN-10 Atm

Code Kod	Diameter Çap (mm)	Coil Length Paket Miktarı (m)	Price Fiyat (USD)/m
502-1103220	20	100 m kangal	1,25
502-1103225	25	100 m kangal	1,75
502-1103232	32	100 m kangal	2,70
502-1104040	40	100 m kangal	4,10
502-1105050	50	100 m kangal	6,40
502-1106363	63	100 m kangal	9,95
502-1107575	75	100 m kangal	15,45



CABLE PROTECTION PIPES
ÇOKLAYICI BORULAR

Code Kod	Color Renk	Diameter Çap (mm)	Pipe Length Boru Boyu (m)	Price Fiyat (USD)/m
502-1403232	Black Siyah	40x32x32	200 m kangal	4,90
502-3403232	Orange Turuncu	40x32x32	200 m kangal	5,45
502-1503232	Black Siyah	50x32x32	200 m kangal	5,30
502-3503232	Orange Turuncu	50x32x32	200 m kangal	5,75
502-2403232	Black Siyah	40x40	200 m kangal	5,30
502-5403232	Orange Turuncu	40x40	200 m kangal	5,75



PE 80 NATURAL GASS PIPES

PE 80 DOĞALGAZ BORULARI



SDR 26

SDR 26

Code Kod	Diameter Çap (mm)	Thickness Kalınlık (mm)	Weight Ağırlık (kg)	Box Quantity Paket Miktarı (m)
505-08026063000	63	2.5	0.48	4m - 8m - 11.8m - 13.5m
505-08026075000	75	2.9	0.66	4m - 8m - 11.8m - 13.5m
505-08026090000	90	3.5	0.95	4m - 8m - 11.8m - 13.5m
505-08026110000	110	4.2	1.40	4m - 8m - 11.8m - 13.5m
505-08026125000	125	4.8	1.82	4m - 8m - 11.8m - 13.5m



SDR 17.6

SDR 17.6

Code Kod	Diameter Çap (mm)	Thickness Kalınlık (mm)	Weight Ağırlık (kg)	Box Quantity Paket Miktarı (m)
505-08018063000	63	3.6	0.68	4m - 8m - 11.8m - 13.5m
505-08018075000	75	4.3	0.97	4m - 8m - 11.8m - 13.5m
505-08018090000	90	5.2	1.41	4m - 8m - 11.8m - 13.5m
505-08018110000	110	6.3	2.08	4m - 8m - 11.8m - 13.5m
505-08018125000	125	7.1	2.66	4m - 8m - 11.8m - 13.5m



SDR 17

SDR 17

Code Kod	Diameter Çap (mm)	Thickness Kalınlık (mm)	Weight Ağırlık (kg)	Box Quantity Paket Miktarı (m)
505-08017040000	40	2.4	0.29	4m - 8m - 11.8m - 13.5m
505-08017050000	50	3.0	0.45	4m - 8m - 11.8m - 13.5m
505-08017063000	63	3.8	0.72	4m - 8m - 11.8m - 13.5m
505-08017075000	75	4.5	1.01	4m - 8m - 11.8m - 13.5m
505-08017090000	90	5.4	1.46	4m - 8m - 11.8m - 13.5m
505-08017110000	110	6.6	2.17	4m - 8m - 11.8m - 13.5m
505-08017125000	125	7.4	2.77	4m - 8m - 11.8m - 13.5m



SDR 11

SDR 11

Code Kod	Diameter Çap (mm)	Thickness Kalınlık (mm)	Weight Ağırlık (kg)	Box Quantity Paket Miktarı (m)
505-08011016000	16	3.0	0.13	100m - 200m
505-08011020000	20	3.0	0.17	100m - 200m
505-08011025000	25	3.0	0.21	100m - 200m
505-08011032000	32	3.0	0.28	100m - 200m
505-08011040000	40	3.7	0.43	100m - 200m
505-08011050000	50	4.6	0.67	100m - 200m
505-08011063000	63	5.8	1.06	100m - 200m
505-08011075000	75	6.9	1.50	100m - 200m
505-08011090000	90	8.2	2.14	100m - 200m
505-08011110000	110	10.0	3.18	100m - 200m
505-08011125000	125	11.4	4.12	100m - 173m
505-08011140000	140	12.70	5.14	6m-13,5m
505-08011160000	160	14.60	6.75	6m-13,5m
505-08011180000	180	16.40	8.53	6m-13,5m
505-08011200000	200	18.20	10.52	6m-13,5m
505-08011225000	225	20.50	13.32	6m-13,5m
505-08011250000	250	22.70	16.40	6m-13,5m

CORRUGATED KORUGE

SEWER PIPE and FITTINGS

KANALİZASYON BORUSU ve EK PARÇALARI



SANICA PIPE FACTORY - ELAZIĞ / TURKEY

SANICA BORU FABRİKA - ELAZIĞ / TÜRKİYE

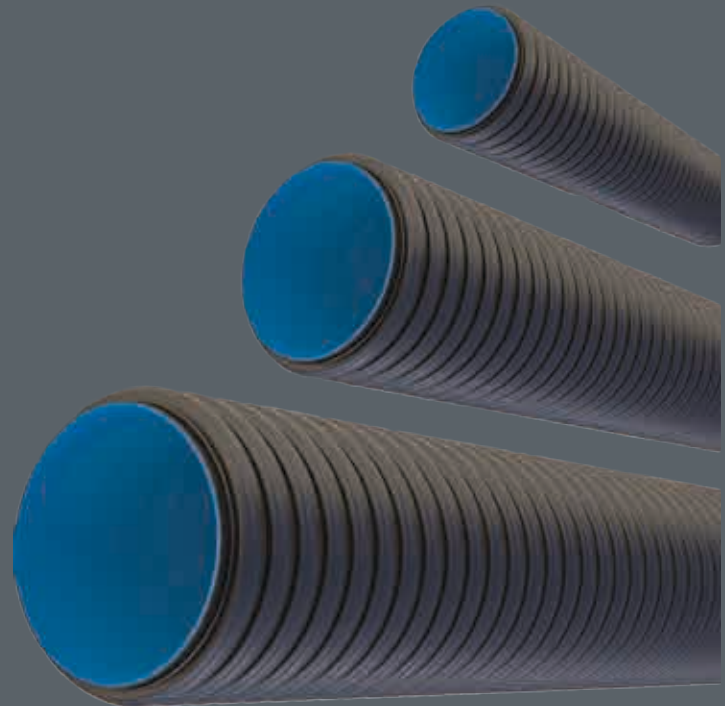

BORU PIPE

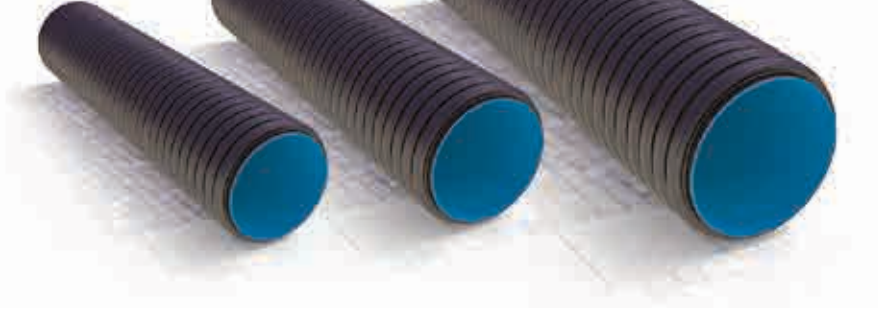

SANIMAX WITHOUT SOCKET
SANIMAX MUFSUZ BORU

Code Kod	Diameter Çap (mm)	SN (kN/m ²)	Lenght Uzunluk (m)	Price Fiyat (USD)/m
504-236410	100	4	6-13	1,92
504-236415	150	4	6-13	3,00
504-236420	200	4	6-13	5,02
504-236430	300	4	6-13	10,80
504-236440	400	4	6-13	18,10
504-236450	500	4	6-13	29,48
504-230461	600	4	6-13	47,95
504-230481	800	4	6-13	82,50
504-2304110	1000	4	6-13	144,38
504-230809	100	8	6-13	2,35
504-230819	150	8	6-13	4,19
504-230829	200	8	6-13	5,91
504-230839	300	8	6-13	13,95
504-230849	400	8	6-13	25,48
504-230859	500	8	6-13	37,00
504-230861	600	8	6-13	59,75
504-230881	800	8	6-13	111,62
504-2308101	1000	8	6-13	196,23

SANIMAX PIPE WITH SOCKET
SANIMAX KENDİNDEN MUFLU BORU

Code Kod	Diameter Çap (mm)	SN (kN/m ²)	Lenght Uzunluk (m)	Price Fiyat (USD)/m
504-230411	200	4	6	5,13
504-230423	300	4	6	11,02
504-230424	400	4	6	18,47
504-230425	500	4	6	30,08
504-230426	600	4	6	48,92
504-230428	800	4	6-13	84,19
504-2304210	1000	4	6-13	147,33
504-230811	200	8	6	6,03
504-230823	300	8	6	14,23
504-230824	400	8	6	26,00
504-230825	500	8	6	37,76
504-230826	600	8	6	61,16
504-230828	800	8	6-13	113,9
504-2308210	1000	8	6-13	200,37

* DN 800 mm ve DN 1000 mm Kendinden Muflu Koruge Borularımız istenilen boylarda muflu olarak üretilebilmektedir.



CORRUGATED PIPE
MUFSUZ KORUGE BORU

Code Kod	Diameter Çap (mm)	SN (kN/m ²)	Lenght Uzunluk (m)	Price Fiyat (USD)/m
504-236410 T	100	4	6-13	3,20
504-236415 T	150	4	6-13	6,00
504-236420 T	200	4	6-13	7,45
504-236430 T	300	4	6-13	21,10
504-236440 T	400	4	6-13	45,50
504-230451 T	500	4	6-13	51,00
504-230461 T	600	4	6-13	69,00
504-230481 T	800	4	6-13	126,00
504-2304110 T	1000	4	6-13	201,00
504-230809 T	100	8	6-13	3,40
504-230819 T	150	8	6-13	6,30
504-230829 T	200	8	6-13	8,00
504-230839 T	300	8	6-13	24,00
504-230849 T	400	8	6-13	48,00
504-230859 T	500	8	6-13	53,50
504-230861 T	600	8	6-13	71,50
504-230881 T	800	8	6-13	132,00
504-2308101 T	1000	8	6-13	203,00

CORRUGATED PIPE WITH SOCKET
KENDİNDEN MUFLU KORUGE BORU

Code Kod	Diameter Çap (mm)	SN (kN/m ²)	Pipe Lenght Boru Boyu (m)	Price Fiyat (USD)/m
504-230411 T	200	4	6	8,20
504-230423 T	300	4	6	22,50
504-230424 T	400	4	6	47,00
504-230425 T	500	4	6	52,00
504-230426 T	600	4	6	72,00
504-230428 T	800	4	6-13	130,00
504-2304210 T	1000	4	6-13	205,00
504-230811 T	200	8	6	8,60
504-230823 T	300	8	6	24,30
504-230824 T	400	8	6	50,00
504-230825 T	500	8	6	55,00
504-230826 T	600	8	6	77,00
504-230828 T	800	8	6-13	138,00
504-2308210 T	1000	8	6-13	215,00

* Our can be produced DN 800 mm and DN 1000 mm with coupling corrugated pipes if your want to 6-13 meters lenghts.

SEWER PIPE FITTINGS

KANALİZASYON BORUSU EK PARÇALARI



COUPLING
MANŞON

Code Kod	Diameter Çap (mm)	Price Fiyat (USD)/pcs
504-230110	100	1,32
504-230115	150	2,10
504-230120	200	3,25
504-230130	300	8,00
504-230140	400	17,15
504-230150	500	74,30
504-230160	600	132,00
504-230180	800	252,00
504-2301100	1000	320,00

GASKET
CONTA

Code Kod	Diameter Çap (mm)	Price Fiyat (USD)/pcs
702-230510	100	0,40
702-230515	150	0,82
702-230520	200	1,32
702-230530	300	3,85
702-230540	400	7,00
702-230550	500	9,30
702-230560	600	18,55
702-230580	800	36,30
702-230610	1000	69,50

C PIECE PVC OUTPUT
C PARÇA PVC ÇIKIŞLI

Code Kod	Diameter Çap (mm)	Price Fiyat (USD)/pcs
702-23031510	150/100	11,00
702-23031515	150/150	16,00
702-23032010	200/100	12,00
702-23032015	200/150	17,00
702-23032020	200/200	29,00
702-23033010	300/100	30,00
702-23033015	300/150	32,00
702-23033020	300/200	35,00
702-23034010	400/100	75,00
702-23034015	400/150	78,00
702-23034020	400/200	83,00



C PIECE CORRUGATED OUTPUT
C PARÇA KORUGE ÇIKIŞLI

Code Kod	Diameter Çap (mm)	Price Fiyat (USD)/pcs
504-23021510	150/100	11,00
504-23021515	150/150	16,00
504-23022010	200/100	12,00
504-23022015	200/150	17,00
504-23022020	200/200	29,00
504-23023010	300/100	30,00
504-23023015	300/150	32,00
504-23023020	300/200	35,00
504-23023030	300/300	45,00
504-23024010	400/100	75,00
504-23024015	400/150	78,00
504-23024020	400/200	83,00
504-23024030	400/300	85,00
504-23024040	400/400	115,00

T PIECE
T PARÇASI

Code Kod	Diameter Çap (mm)	Price Fiyat (USD)/pcs
702-232215	150/100	11,00
702-231515	150/150	16,00
702-232220	200/100	12,00
702-232015	200/150	16,20
702-232221	200/200	27,00
702-233010	300/100	30,00
702-230331	300/150	31,00
702-232230	300/200	32,00
702-232330	300/300	45,00
702-234010	400/100	70,00
702-234015	400/150	72,00
702-234020	400/200	75,00
702-234030	400/300	80,00
702-23024040	400/400	110,00

45° ELBOW
DİRSEK 45°

Code Kod	Diameter Çap (mm)	Price Fiyat (USD)/pcs
704-234510	100	8,50
704-234515	150	9,00
704-234520	200	13,15
704-234530	300	25,15
704-234540	400	69,00

SEWER PIPE FITTINGS

KANALİZASYON BORUSU EK PARÇALARI



90° ELBOW DİRSEK 90°

Code Kod	Diameter Çap (mm)	Price Fiyat (USD)/ pcs
704-239010	100	9,50
704-239015	150	10,00
704-239020	200	14,30
704-239030	300	30,00
704-239040	400	80,00

REDUCER REDÜKSİYON

Code Kod	Diameter Çap (mm)	Price Fiyat (USD)/pcs
702-2301510	150/100	11,00
702-2302210	200/100	12,00
702-2302215	200/150	13,00
702-2302310	300/100	22,00
702-2302315	300/150	23,00
702-2302320	300/200	24,00
702-2302410	400/100	48,00
702-2302415	400/150	51,00
702-2302420	400/200	52,00
702-2302430	400/300	58,00

ADAPTOR ADAPTÖR

Code Kod	Diameter Çap (mm)	Price Fiyat (USD)/pcs
702-92321510	150/110	10,00
702-92321516	150/160	10,50
702-92322011	200/110	11,50
702-92322016	200/160	12,50
702-92322020	200/200	17,15
702-92323015	300/150	24,00
702-92323020	300/200	27,00
702-92324016	400/160	51,00
702-92324020	400/200	53,00

CORRUGATED (Conduit Pipe) KORUGE (Telekom)

Code Kod	Diameter Çap (mm)	Pipe Length Boru Boyu (m)	Price Fiyat (USD)/m
504-230610	100	7	2,45
504-230615	150	7	3,90
504-230620	200	7	6,30



PVC BASINÇLI
TEMİZ SU BORUSU

**PVC PRESSURE
CLEAN WATER PIPE**



PRESSURE CLEAN WATER PIPES

PVC BASINÇLI TEMİZ SU BORULARI

6 ATU PVC PRESSURE CLEAN WATER PIPES

6 ATÜ PVC TEMİZ SU BORULARI

Code Kod	Diameter Çap (mm)
503-232005	50
503-232006	63
503-232007	75
503-232009	90
503-232011	110
503-232012	125
503-232014	140
503-232016	160
503-232020	200
503-232022	225
503-232025	250
503-232028	280
503-232031	315
503-232035	355
503-232040	400

10 ATU PVC PRESSURE CLEAN WATER PIPES

10 ATÜ PVC TEMİZ SU BORULARI

Code Kod	Diameter Çap (mm)
503-232105	50
503-232106	63
503-232107	75
503-232109	90
503-232111	110
503-232112	125
503-232114	140
503-232116	160
503-232120	200
503-232122	225
503-232125	250
503-232128	280
503-232131	315
503-232135	355
503-232140	400

16 ATU PVC PRESSURE CLEAN WATER PIPES

16 ATÜ PVC TEMİZ SU BORULARI

Code Kod	Diameter Çap (mm)
503-232205	50
503-232206	63
503-232207	75
503-232209	90
503-232211	110
503-232212	125
503-232214	140
503-232216	160
503-232220	200
503-232222	225
503-232225	250
503-232228	280
503-232231	315
503-232235	355
503-232240	400



**PVC PRESSURE PIPES THICKNESS AND WRIGHT
TS EN 1452-2**

OUTSIDE DIMENSION mm	OUTSIDE DIMENSION TOLERANCE	QUALITY	PN 4 ATM			PN 6 ATM			PN 10 ATM			PN 16 ATM					
			THICKNESS		WEIGHT	THICKNESS		WEIGHT	THICKNESS		WEIGHT	THICKNESS		WEIGHT			
			STANDARD [mm]	TOLERANCE [mm]	[kg/m]	STANDARD [mm]	TOLERANCE [mm]	[kg/m]	STANDARD [mm]	TOLERANCE [mm]	[kg/m]	STANDARD [mm]	TOLERANCE [mm]	[kg/m]			
20	0,2	0,5															
25	0,2	0,5															
32	0,2	0,5															
40	0,2	0,5															
50	0,2	0,6															
63	0,3	0,8															
75	0,3	0,9	1,50	0,40	0,512	1,50	0,40	0,329	2,40	0,50	0,517	3,70	0,60	0,775			
90	0,3	1,1	1,60	0,40	0,656	2,70	0,50	1,066	4,30	0,70	1,667	6,70	0,90	2,490			
110	0,4	1,4	1,90	0,40	0,963	2,70	0,50	1,311	4,20	0,70	2,010	6,60	0,90	3,131			
125	0,4	1,5	2,20	0,45	1,263	3,10	0,60	1,710	4,80	0,70	2,610	7,40	1,00	3,937			
140	0,5	1,7	2,50	0,50	1,612	3,50	0,60	2,161	5,40	0,80	3,288	8,30	1,10	4,945			
160	0,5	2,0	3,00	0,50	2,198	4,00	0,70	2,823	6,20	0,90	4,314	9,50	1,20	6,468			
200	0,6	2,4	3,80	0,60	3,486	4,90	0,70	4,325	7,70	1,00	6,699	11,90	1,40	10,126			
225	0,7	2,7	4,30	0,65	4,450	5,50	0,80	5,441	8,60	1,10	8,419	13,40	1,60	12,827			
250	0,8	3,0	4,70	0,70	5,417	6,20	0,90	6,838	9,60	1,20	10,440	14,80	1,70	15,748			
280	0,9	3,4	5,30	0,75	6,840	6,90	0,90	8,525	10,70	1,30	13,036	16,60	1,90	19,781			
315	1,0	3,8	6,00	0,80	8,722	7,70	1,00	10,705	12,10	1,50	16,581	18,70	2,10	25,066			
355	1,1	4,3	6,80	0,90	11,200	8,70	1,10	13,630	13,60	1,60	21,005	21,10	2,40	31,872			
400	1,2	4,8	7,70	1,00	14,728	9,80	1,20	17,299	15,30	1,80	26,627	23,70	2,60	40,366			
450	1,4	5,4															
500	1,5	6,0															
560	1,7	6,8															
630	1,9	7,6															
710	2,0	8,6															
800	2,0	9,6															
900	2,0	21,6															
1000	2,0	24,0															

DRAINAGE PIPES

Drenaj Boruları

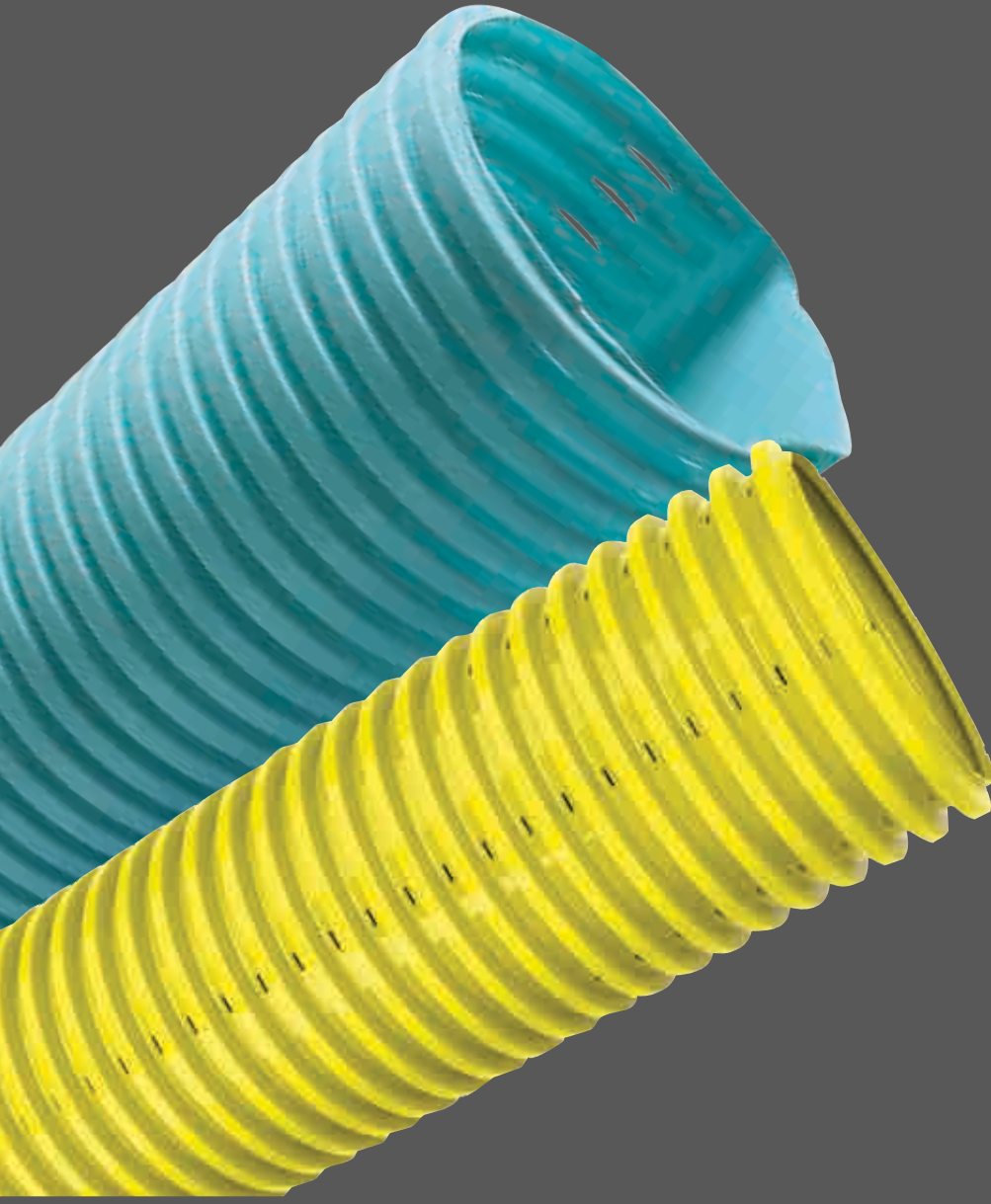

PVC DRAINAGE PIPES
PVC DRENAJ BORULARI

Code Kod	Diameter Çap (mm)	Price Fiyat (USD)
506-100080100001	80	1,27
506-100100100001	100	1,80
506-100125100001	125	2,65
506-100160050001	160	3,55
506-100200025001	200	5,00

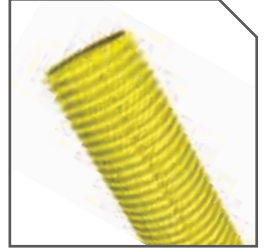

TUNNEL TYPE PVC DRAINAGE PIPES
TÜNEL TİPİ PVC DRENAJ BORULARI

Code Kod	Diameter Çap (mm)	Price Fiyat (USD)
506-200160006001	160	6,45
506-200200006001	200	6,70







SANICA

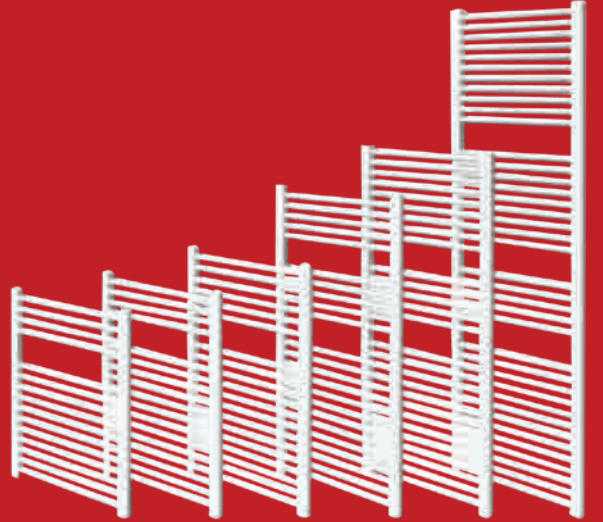

12
years
guarantee

PANEL RADIATOR and TOWEL WARMERS
PANEL RADYATÖR ve HAVLUPAN

SANICA

FACTORIES FABRİKALAR

Radiator Factory Radyatör Fabrikası

Akhisar Organize Sanayi Bölgesi,
3. Cadde, No.: 05 P.K.: 45230
Akhisar / MANİSA - TURKEY

Bath Factory - İstanbul Banyo Fabrikası - İstanbul

Kavaklı Mahallesi, İstanbul Caddesi,
No.:10, P.K.:34520 - Kavaklı
Beylikdüzü / İSTANBUL - TURKEY

Glass Factory Cam Fabrikası

Akhisar Organize Sanayi Bölgesi,
3. Cadde, No.: 05 P.K.: 45230
Akhisar / MANİSA - TURKEY

Boru Fabrikası - İstanbul Pipe Factory - İstanbul

Kavaklı Mahallesi, İstanbul Caddesi,
No.:24, P.K.:34520 - Kavaklı
Beylikdüzü / İSTANBUL - TURKEY

Pipe Factory 2 - İstanbul Boru Fabrikası 2 - İstanbul

Cihangir Mahallesi, E-5 Yan yol üzeri
No.:323-1 P.K.:34310
Avcılar / İSTANBUL - TURKEY

Pipe Factory - Elazığ Boru Fabrikası - Elazığ

Organize Sanayi Bölgesi, 2.Yol
No.:25 P.K.:23180
Yazikonak / ELAZIĞ - TURKEY

Wall Hung Gas Boiler Factory Kombi Fabrikası

Akhisar Organize Sanayi Bölgesi,
3. Cadde, No.: 05 P.K.: 45230
Akhisar / MANİSA - TURKEY

CONTACT İLETİŞİM

Central Office - Merkez Ofis

Kavaklı Mahallesi, İstanbul Caddesi,
No.:10, P.K.:34520 - Kavaklı
Beylikdüzü / İstanbul
Telefon : +90 212 855 80 80 (pbx)
Fax : +90 212 855 80 90
E-mail : sanica@sanica.com.tr

SANICA Dış Ticaret A.Ş. (Export)

Kavaklı Mahallesi, İstanbul Caddesi,
No.:10, P.K.:34520 - Kavaklı
Beylikdüzü / İstanbul
Telefon : +90 212 855 80 80 (pbx)
Fax : +90 212 855 80 90
E-mail : export@sanica.com.tr

SANICA Hungary KFT

2051 Biatorbagy Devay Gyula u.9 1/3
HUNGARY
Telefon : +36 3045 50570
Fax : +36 23 820473
E-mail : barisgur@sanica.com.tr

SANICA Canada Co.

Sanica Canada Co.,
8 Mulberry Crescent Toronto
ON M6C 1N5 CANADA
Telefon : +1 647 909 64 68
E-mail : selimperek@sanica.ca

SANICA England UK

SANICA BUILDING MATERIALS LTD.
Unit L, Stafford Park, Liston, Sudbury,
Suffolk, CO10 7HX United Kingdom
Telefon : 01787275980
Fax : 01787275788
E-mail : sales@sanicauk.com



SANICA



[/sanicaofficial](#)

FATİNOĞLU
HOLDİNG